

PRODUCT CATALOGUE



Contents

Grill Stations	3-5
Conveyor Toasters	6
Eclipse Bun & Snack Toasters	7
Sycloid® Toasters	8-10
Griddles	11-12
Griddle Toasters	13-14
Milkshake & Drink Mixers	15-16
Double Skinned Hot Water Urns	17
Frypods.....	18-19
Carving Station	20
Chip & Food Warmer	21-22
Heat Lamps	
Quartz Heat Lamp Assemblies	23-24
Infra-Red Heating Assemblies	25-26
Optional Mount Kit	27
Modular Heat Lamp	27
Rice Cookers & Warmers.....	28-29

Grill Stations

The modern, stylish Roband Grill Station is available in six or eight slice size models. The Roband range sets the benchmark for commercial contact grills. The versatile unit rapidly toasts sandwiches, paninis and focaccias, in addition to producing beautifully seared and grilled tender meat, poultry and fish. Featuring elements embedded directly into smooth, high pressure die-cast aluminium plates, the cooking surface produces an even, extremely efficient heat transfer ensuring food is cooked rapidly with even colouration.

The Roband Grill Station truly is a must-have for cafes, takeaways, sandwich shops or anywhere that toasting and / or grilling is required.



FEATURES

- Six or eight sandwich capacity
- Quality high pressure die-cast aluminium cooking plates with cast-in elements for efficient, directional and effective heat transfer
- Precise thermostat for controlling cooking temperature
- Even temperature distribution across each plate and between the top and bottom plates
- Ability to switch between top and bottom plate operation or bottom plate only operation
- A counter-balanced top plate and an arched handle makes operating the Grill Station easy
- Easy one-handed loading and unloading of food with the top plate capable of staying partially open at an approximate 45° angle
- A load limiter that reduces the resting weight of the top plate on food being grilled or toasted
- Plate spacers are available separately for very thin contents
- High splash guard with top plate always positioned over bottom plate ensuring grease and crumbs fall onto bottom plate
- A front positioned grease collection box collects grease and crumbs and is well-positioned for easy removal and cleaning
- Small counter space requirement due to the elimination of a cumbersome back cable
- Angled control panel for clear visibility of settings
- 5 minute timer with warning bell
- Includes one premium spatula
- Optional ribbed top plate
- Optional non-stick Grill Sheet (PTFE) & Retainer Clip keeps the plates clean, prevents food sticking and is removable, cleanable & replaceable
- Optional side draining grease channel for high volume waste (model RGC6 or RGC8, see page 5)

Grill Stations

FEATURES & OPTIONS FOR ALL GRILL STATIONS

Top plate props open for easy access to food

GSA610S pictured

Plate options

Top plate always positioned over bottom plate

High splash guard

Removable grease tray

Top & bottom or bottom only plate selection

Thermostat control

Timer

No cumbersome back cable, reducing counter space required

Smooth plate

Ribbed top plate



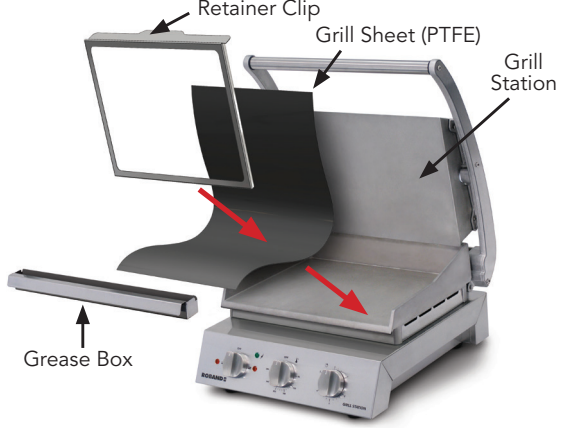
OPTIONAL REMOVABLE GRILL SHEET (PTFE) WITH RETAINER CLIP

Retainer Clip

Grill Sheet (PTFE)

Grill Station

Grease Box



Grill Stations

SPECIFICATIONS

MODEL	SLICES No.	TOP PLATE	POWER watts	CURRENT amps	DIMENSIONS w x d x h (mm)	BOTTOM PLATE DIMENSIONS w x d (mm)
GSA610S	6	SMOOTH	2200	9.6	435 x 490 x 220	375 x 275
GSA610R	6	RIBBED	2200	9.6	435 x 490 x 220	375 x 275
GSA815S	8	SMOOTH	2990	13.0	560 x 490 x 220	500 x 275
GSA815R	8	RIBBED	2990	13.0	560 x 490 x 220	500 x 275

Note: All bottom plates are smooth. Timer does not over-ride or control thermostat.
Maximum height when top fully open is 580 mm.

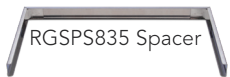
PATTERN PLATES

Premium spatula pictured

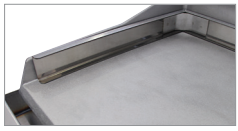


PLATE SPACER

Spacers available in various sizes to suit



RGSPS835 Spacer inside a GSA810S



REAR STAND



GSA810S sitting on a rear stand RS830



Showing easy installation on a Grill Station top plate



Showing easy installation on a Grill Station bottom plate



SIDE DRAINING GREASE CHANNEL

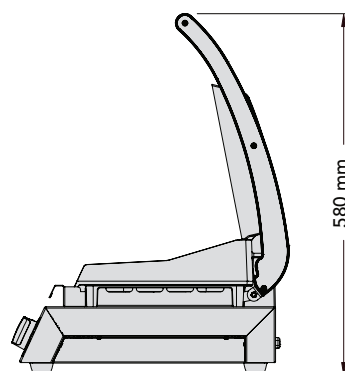
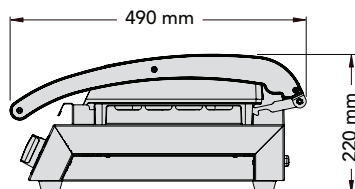
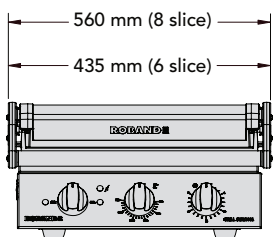


Pan not included.

ACCESSORIES

Grill Station Models	Sheet Retainer Clip Model Number	Grill Sheet (PTFE) (non-stick) Model Number	Side Draining Grease Channel	Rear Stand	Plate Spacer	Aluminium Grill Pattern Plate
GSA610	RRC6	RPGS605 (5 pack QTY) RPGS610 (10 pack QTY)	RGC6	RS630	RGSPS625, RGSPS635, RGSPS645	RGS6-P1 (a set of 2)
GSA815	RRC8	RPGS805 (5 pack QTY) RPGS810 (10 pack QTY)	RGC8	RS830	RGSPS825, RGSPS835, RGSPS845	RGS8-P1 (a set of 2)

DIMENSIONS - ALL MODELS



Conveyor Toasters

When it comes to serving large quantities of toasted bread, crumpets or muffins in a hurry, Roband conveyor toasters are the answer.

With the capacity to toast up to 300 slices per hour*, this toaster can handle the heaviest demands. Add the convenience of the front load/front return feature and you have an unbeatable combination.



FEATURES

- Stainless steel body
- Selectable heat source top or bottom or both together
- Front entry, adjustable front return or pass through exit chute
- Variable electronic conveyor speed control
- Cover for speed controller switch so guests don't alter setting
- Easy-clean crumb tray & reflector
- Dura-life stainless steel elements for prolonged element life



TCR15 pictured.
TCR10 looks identical.

Adjustable front or rear exit chute
(rear exit pictured)



Easily removable crumb tray
& reflector



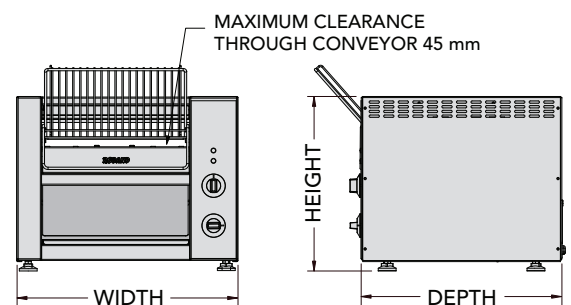
Speed controller cover



SPECIFICATIONS

MODEL	SLICES/HR (up to)	POWER watts	CURRENT amps	DIMENSIONS w x d x h (mm)
TCR10	300*	2300	10.0	475 x 430 x 370

*Variations may occur depending on voltage supply and bread product (see page 30).



Eclipse Bun & Snack Toasters

Providing ultimate toasting control for back-of-house kitchen staff, the Eclipse is designed for high speed bun toasting and toasting of small bread based snack items. The machine provides precise and independent variable heat control of the top element and bottom element to enable users to produce the desired result on each side of their product.



FEATURES

- Modern brushed stainless steel construction
- Independent and precise variable control of top and bottom element heat output
- Solid State Electronics offer precise temperature control and greater component reliability, creating the exact toasting environment to suit many products
- Control of conveyor belt speed
- Two entry chutes providing different entry angles, standard wire 48° or stainless steel 25°
- Front return or pass through chute operation
- Adjustable angle on rear chute – 3 angles (10°, 17.5°, 25°)
- Dura-life stainless steel elements for prolonged element life
- Removable crumb trays for easy cleaning
- 40 mm entry chute clearance
- Maximum toasting diameter up to: return chute 130 mm, pass-through 310 mm



ET315 pictured.
ET310 looks identical.



ET315 showing front chute and rear chute at adjustable angles. ET310 looks identical.

SPECIFICATIONS

MODEL	BREAD SLICES/HR (up to)	BUN HALVES/HR (up to)	POWER watts	CURRENT amps	DIMENSIONS w x d x h (mm)
ET310	300*	270*	2300	10.0	480 x 485 [^] x 400 [^]

*Variations may occur depending on voltage supply and bread product (see page 30).

[^]Depth and height does not include protruding racks/chutes.



ET315 showing rear pass through chute. ET310 looks identical.

Sycloid® Toasters

Elegantly designed and crafted, the revolutionary Sycloid® toaster sets a new standard for high speed toast production. The Sycloid's stylish exterior houses a cleverly engineered machine that provides truly functional energy efficient operation and an outstanding toasting result time after time.

 **sycloid®**
TOASTER



FEATURES

- Available in red, black or natural colours, producing over 500 slices per hour.
- All Sycloid toasters deliver excellent toasting results for bread up to 30 mm thickness. As most bread used in buffets is expected to be less than 20 mm thickness, the Sycloid is optimised to deliver its best result for bread of this thickness, but can accommodate slices up to 30 mm.
- The bun toast feature allows for toasting bun halves up to 30 mm thick. The Sycloid balances heat to perfectly toast on the cut side - whilst warming the crown.
- Patron and staff safety is paramount and the Sycloid® toaster has been designed with "cool to touch" safe external touch temperatures and a lid locking latch.
- Intelligent energy efficient design – an automatic power-save mode conserves energy during quiet periods by scaling back energy consumption when in toast mode. The intelligent auto-sense feature detects when a new slice is placed in the machine and automatically prepares the machine to toast the bread. The heat setting in this mode is balanced and optimised to ensure quick recovery.
- A user-friendly and reliable speed controller allows adjustment of the toasting time to account for different types of bread or buns to be toasted. The knob setting lock feature allows staff to set the toasting speed, removing the risk of patrons altering the setting.
- Diners can easily see when their toast is ready from across the buffet with the stylishly sculpted toast return chute with LED lighting that provides easy and illuminated viewing of the toast holding bay. The wide opening of the bay allows easy access to toast, which the radiant heat from the elements helps to keep warm.
- Featuring robust stainless steel elements, the Sycloid® toaster also features a modern brushed stainless steel exterior, perfect for disguising finger prints on a machine expected to be heavily used. It also includes a slide-out crumb tray for every-day cleaning and a hinged top cover allowing easy access to clean the inside.
- The Sycloid® toaster produces a beautiful toasting result throughout the entire slice of bread.

Sycloid® Toasters

The Hottest Toaster that's "Cool-to-Touch"

FEATURES



Also available in these colours:



Red







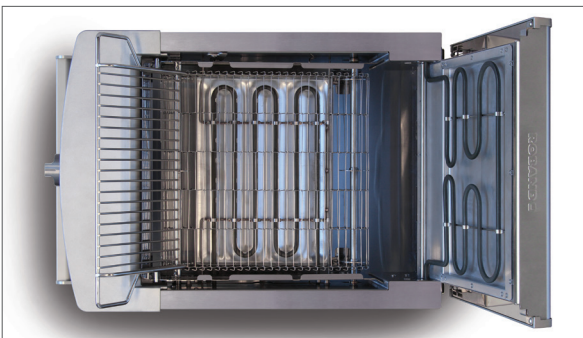


Black

With bun toasting mode

Sycloid® Toasters

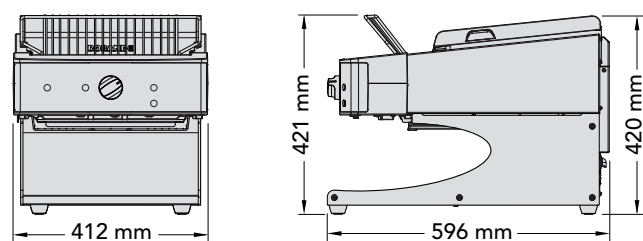
FEATURES

<p>Toasting speed controller with electronic lock setting feature</p>	<p>Indicator light for auto-sensing feature</p>	<p>Bun toasting mode (up to 30 mm thickness)</p>	<p>Removable crumb tray for ease of cleaning</p>
			
<p>Lid-lock release lever to lift lid</p>	<p>LED lights illuminate the toast holding bay</p>	<p>Hinged top cover for easy access to clean inside</p>	
			

SPECIFICATIONS

MODEL	COLOUR	SLICES / HR (min)	CURRENT amps	POWER watts	DIMENSIONS W x D x H (mm)	WEIGHT kg
ST500A	Natural	500	13.0	2990	412 x 596 x 421	25
ST500AR	Red	500	13.0	2990	412 x 596 x 421	25
ST500AB	Black	500	13.0	2990	412 x 596 x 421	25

DIMENSIONS



Griddles

From the outside, all brands of Griddles look quite similar but, it's what's inside a Griddle that determines how well the machine will perform under pressure and when you need it the most.



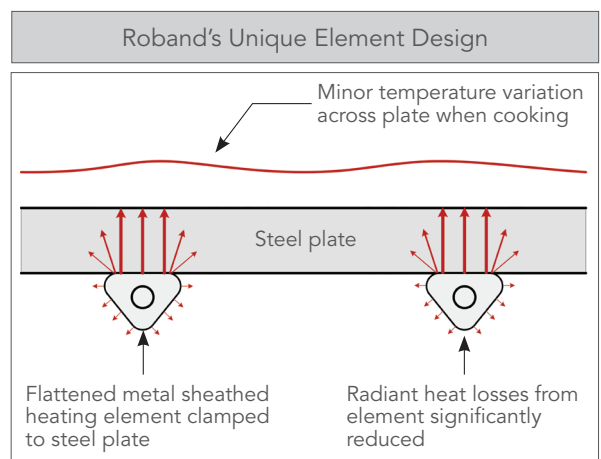
This is where Roband Griddles are set apart from the competition and allow you to precisely cook a variety of food from steaks, chicken, fish and burger patties, fritters to eggs and bacon.

All Roband griddles feature uniquely designed elements that provide maximum temperature penetration specifically into the thick, steel griddle plate. The unique element design results in a smooth, controllable and even temperature across the cooking surface.

Roband Griddles help you achieve:

- 1) Faster cooking times with rapid temperature recovery when loaded with food
- 2) Lower power consumption and heat losses
- 3) Even temperatures for professional cooking
- 4) Reliable food quality outcomes

Both Griddles offered in the Roband range deliver best in class performance. Every machine plate size has been engineered to deliver the best cooking experience possible from the power supplied.

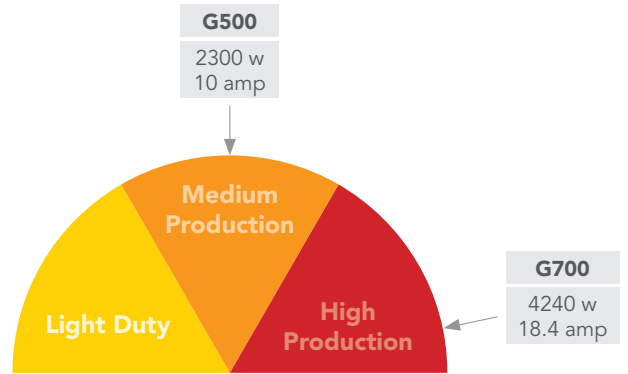


FEATURES

- 8 mm thick griddle plates for superior heat retention
- Superior, compacted griddle plate elements for fast temperature recovery and reliable temperature control
- Thermostat control for precise cooking temperature. Dual on G700 for control of left and right side of plate
- Large capacity forward positioned grease box which is dual skin for lower touch temperatures and integrated into machine to reduce risk of spillage and minimise bench space

Griddles

GRIDDLE SELECTION GUIDE



G500 pictured



G700 pictured

SPECIFICATIONS

MODEL	POWER watts	CURRENT amps	PHASE	DIMENSIONS ^ w x d x h (mm)	COOKING SURFACE w x d (mm)
G500	2300	10	1	538 x 443 x 263	515 x 340
G700*	4240	18.4	1 or 2 (+N)	725 x 529 x 263	700 x 400

*Installation must be carried out by a licensed electrician. For this reason, the G700 model does not come with a plug and cord. The decision on connection options should be made under consultation with your electrician. Can be wired for Single Phase or 2 phase + n. We recommend using more than 1 phase for this machine as multiple phases will help evenly balance load and will reduce stress on product components. ^Dimensions include grease box.

Griddle Toasters



Griddle Toasters are the perfect combination machine to produce a great top toasting result, whilst precisely cooking your steaks, eggs, bacon or hamburgers on the griddle cooking plate.

Each model within the Roband Griddle Toaster range has been engineered to maximise the performance of the machine in both the griddle and toasting functions.

They all feature separate elements for the heavy steel griddle plate as well as the toasting compartments to ensure consistent and optimal results across both functions.

Two Griddle Toaster models are available:

- 1) GT480 - honed to provide maximum punch from 10 amps, caters to outlets that are limited by power supply, but still have a need for both griddle and top-toasting functions.
- 2) GT700 - is for very busy operations with a need to produce significant volumes of food from a bench-top machine.

With a comprehensive, diverse and well-designed range of Griddle Toasters, a Roband solution can be found to suit almost any counter top application.

FEATURES:

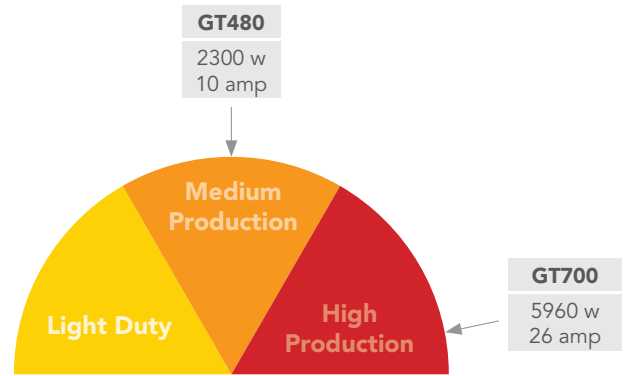
- 8 mm thick steel cooking plates for superior heat retention (GT480 features 6 mm plate)
- Superior, compacted cooking plate elements for fast temperature recovery and reliable temperature control
- Thermostat control for precise griddle plate cooking temperature
- Dual element system has independent control of the toasting function and griddle plate function, providing optimum cooking control for kitchen staff. The toasting compartment of all models is designed to work in tandem with the hotplate operation. (Note GT480 toast elements are controlled by the On/Off switch)
- The larger GT700 model features independent operation of the left or right side of the griddle and toaster for efficient use in quiet periods
- Large capacity forward positioned grease box which is dual skin for lower touch temperatures and integrated into machine to reduce risk of spillage and minimise bench space
- Toasting crumb tray is removable for easy cleaning of toasting compartment

Griddle Toasters

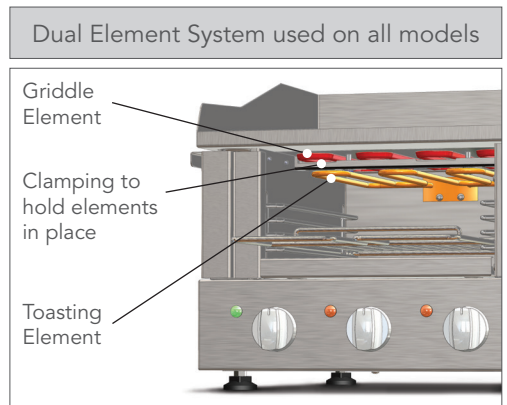
Griddle Toaster Selection Guide



GT480 pictured



GT700 pictured



SPECIFICATIONS

MODEL	POWER watts	CURRENT amps	PHASE	DIMENSIONS [^] w x d x h (mm)	COOKING SURFACE w x d (mm)	MAX. FOOD CLEARANCE (mm)
GT480	2300	10.0	1	495 x 425 x 374	480 x 308	70
GT700*	5960	26.0	1, 2 or 3 (+N)	725 x 541 x 374	700 x 400	70

*Installation must be carried out by a licensed electrician. For this reason, the GT700 model does not come with a plug and cord. The decision on connection options should be made under consultation with your electrician. Can be wired for Single Phase, 2 phase + n or 3 phase + n. We recommend using more than 1 phase for this machine as multiple phases will help evenly balance load and will reduce stress on product components. [^]Dimensions include grease box and do not include the protruding rack.

Milkshake & Drink Mixers



DM21G
Graphite

DM21W
White

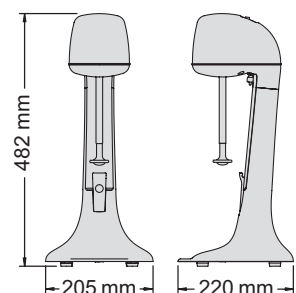
DM21R
Red

Roband milkshake mixers are the ideal machine for making perfect thickshakes or milkshakes every time. The Saturn beater produces extra fluffy shakes using minimal ingredients, time after time. Merging style, power and performance these mixers are a must for cafes and fast food outlets.

FEATURES

- Powerful two-speed motor, 18,000 RPM on low and 22,000 RPM on high speed
- Saturn beater for extra fluffy shakes, stainless steel beaters also included for use with ice cream
- Separate two-speed on/off switch with protective cover
- Available in red, white, black, graphite, seaspray & metallic
- Easy-clean base for cleaning spillage
- High performance stainless steel mixing spindle
- Takes standard 710 ml (24 fl.oz.) cups without tilting to remove
- Stainless steel cup included
- 'Hands free' operation when mixing cup is resting on the cup support

DIMENSIONS





Saturn beater for extra fluffy shakes



Stainless steel wave beater for soft serve ice cream



Stainless steel conical beater for thickshakes



SPECIFICATIONS

MODEL	COLOUR	POWER watts	CURRENT amps
DM21W	White	150	0.7
DM21B	Black	150	0.7
DM21R	Red	150	0.7
DM21G	Graphite	150	0.7
DM21S	Seaspray	150	0.7
DM21M	Metallic	150	0.7

Easy-clean base for cleaning spillage



Two-speed on/off switch with protective cover



Double Skinned Hot Water Urns

Robatherm Hot Water Urns are stylishly finished and designed for commercial use. The Urns feature a unique mode selector switch that allows either variable or pre-set temperature control, providing ultimate flexibility and ease of use.

With the mode set to variable, the temperature can be controlled across a wide range via the graduated knob. Variable mode will suit those users who require warm or boiling water for their special application.

Switching the mode selector to pre-set will fix the temperature at 95 °C, the optimal temperature for most applications involving tea and coffee. Using pre-set mode offers a fast and easy setup, achieving consistent temperatures every time. Adjustment of the knob in pre-set mode has no effect on the temperature setting of the urn - it remains constant at nominal 95 °C. This prevents continuous boiling and excessive consumption of energy.



UDS10VP pictured



UDS20VP pictured

FEATURES

- Mode selector switch for either variable or pre-set 95 °C temperature control
- Available in 10, 20 or 30 litre sizes
- Double skinned tank construction for safe side temperatures, less than 50 °C
- Long life concealed elements allowing easy cleaning inside the urn
- Stylish brushed finish stainless steel exterior
- High grade 304 stainless steel inner tank
- Sturdy stainless steel non-drip tap
- Twist-lock lid with steam vent
- Sight-glass with cup capacity graduations
- Boil dry protection

SPECIFICATIONS

MODEL	CAPACITY* Cups (160 ml)	POWER watts	CURRENT amps	DIMENSIONS dia. x h (mm)
UDS10VP	50	2300	10.0	240 x 480
UDS20VP	120	2300	10.0	330 x 550
UDS30VP	160	2300	10.0	330 x 645

*Approximate capacity.

Sturdy stainless steel non-drip tap



Double skin tank with concealed element



Variable or pre-set temperature functionality



Frypod Counter Top Fryers

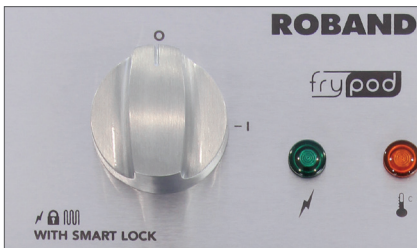
Breaking new ground with its innovative design, the Roband Frypod excels with its performance, safety and cleanliness of operation.

Delivering perfectly fried food time after time, the responsiveness of the Frypod elements to any drop in temperature has been honed and the temperature band that the fryer continues to operate in when loaded with food has been tightened.

This ensures that the temperature drop of the oil is minimised during the cooking process, delivering consistent, perfect results. It also means less oil in the food and longer oil life. With a modern brushed stainless steel finish, the sleek exterior also houses a simple but clever safety lock mechanism that prevents users from removing the elements when the machine is switched on and prevents the machine from being turned on when the elements are removed.



Smart safety lock mechanism prevents element removal when machine is on



Elements swing back and lock in place for element draining and tank removal



Bevelled fryer body providing a lip for easy tank removal



Single Pan Frypods

FEATURES

- Precise thermostat control
- Modern brushed stainless steel finish
- Splashguard with bash plate that returns oil to tank
- Safety lock mechanism prevents element removal when machine is on
- Elements swing back and lock in place for draining and tank removal
- Bevelled fryer body for easy tank removal
- Safety over-temperature cut-out
- Max & min oil level markers
- Element guard and capillary protection
- Multi-functional fryer lid included
- Isolating switch
- Insulated basket handle



FR15 pictured

SPECIFICATIONS

MODEL	TANK litres	POWER watts	CURRENT amps	MACHINE DIMENSIONS w x d x h (mm)	HEAT UP TIME, Mins (25 - 180 °C)	THAWED CHIPS PROD. kg/hr	FROZEN CHIPS PROD. kg/hr	BASKET SIZE* w x d x h (mm)
FR15	5	2300	10.0	290 x 480 x 335	11	7	6.5	215 x 215 x 137

*All these models have the same basket chip capacity of 1 kg.

Double Pan Frypods

Featuring two pans and two baskets the choice is yours, double the quantities, stagger the orders or keep food separate.

FEATURES

- Precise thermostat control
- Modern brushed stainless steel finish
- Safety lock mechanism prevents element removal when the machine is on
- Elements swing back and lock in place for draining and tank removal
- Bevelled fryer body for easy tank removal
- Splashguards with bash plate that returns oil to tank
- Multi-functional fryer lids included
- Safety over-temperature cut-out
- Max & min oil level markers
- Element guard and capillary protection
- Insulated basket handles
- Isolating switch



FR25

SPECIFICATIONS

MODEL	TANK litres	POWER watts	CURRENT amps	MACHINE DIMENSIONS w x d x h (mm)	HEAT UP TIME, Mins (25 - 180 °C)	THAWED CHIPS PROD. kg/hr	FROZEN CHIPS PROD. kg/hr	BASKET SIZE* w x d x h (mm)
FR25	2 x 5	2 x 2300	2 x 10.0	570 x 480 x 335	11	14	13	215 x 215 x 137

*All these models have the same basket chip capacity of 1 kg.

Carving Station

Roband carving stations are the ideal solution for cafes, clubs and restaurants to keep roasted meat warm, illuminated and moist prior to serving.

Heat from above and below combines with steam from the pan to deliver moisture and heat. The perforated and spiked pan keeps the meat secure for carving, whilst the larger pan sitting underneath contains the water to produce steam and collects any fat drippings.



FEATURES

- Heat source from above and below
- Energy regulator control of element (heating from below)
- Crumb/drip tray
- Full size pan (65 mm deep) with full size perforated and spiked pan (25 mm deep)
- Maximum pan depth 65 mm
- Adjustable feet
- Stainless steel construction

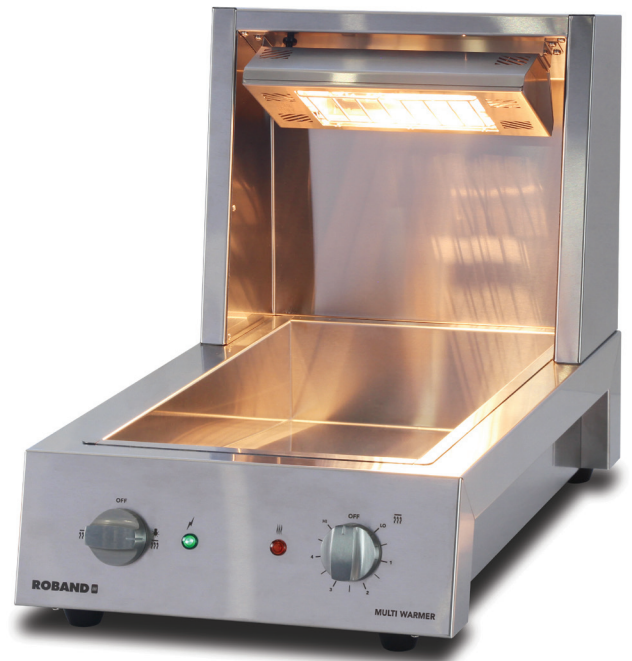
SPECIFICATIONS

MODEL	POWER watts	CURRENT amps	DIMENSIONS w x d x h (mm)
CS10	1750	7.6	355 x 650 x 570



CS10 pictured

Chip and Food Warmer



The multi-function food and chip warmer is a compact bench-top warmer that can accommodate a range of accessories to suit the type of hot food being displayed. With heat source from above (quartz heat lamp) and from below (stainless steel elements), the unit attractively holds and displays hot food, ready for service.

MW10 – Base Unit

The MW10 is supplied without any accessories or trays. It can accommodate a range of gastronorm pan configurations to suit the specific hot food being displayed. Combinations of pans up to a full sized 1/1 (100 mm deep) gastronorm pan can be accommodated. With heat from above and below, the MW10 can hold cooked food at correct serving temperature whilst being appealingly displayed.

MW10CW – Chip Warmer

Supplied with a sloping tray for chips, the MW10CW is designed to enhance productivity and presentation of cooked chips. Heating from above and below, the unit maintains cooked chips at the correct serving temperature and allows the fryer basket to be immediately returned to the fryer for the next batch, increasing fryer productivity. At the same time, the heat lamp serves to throw heat and a yellow light onto the cooked chips to enhance presentation.

MW10CS – Carving Station

The MW10CS is supplied with a full size (65mm deep) gastronorm pan with a full size perforated and spiked pan (25mm deep) so that the unit can be used as a carving tray. The perforated and spiked tray secures the meat for easy carving, whilst the larger pan sitting underneath holds water to produce steam and keep the meat moist and collects any fat drippings. The heat lamp throws a warm yellow light over the meat to enhance presentation.

Chip and Food Warmer

THE RANGE



MW10 - Base Unit shown with optional 1/1 gastronorm pan 100 mm deep (sold separately)



MW10CW - Chip Warmer



MW10CS - Carving Station

Enhance productivity and presentation by creating an area to hold, serve and display cooked chips with this portable multi-function Chip and Food Warmer.



FEATURES

- Halogen Heat lamp
 - Heat source from above (Easy Fit heat lamp) and below (stainless steel element)
 - Energy regulator control of element (heating from below)
 - Ultra-durable stainless steel element
 - Three models available;
- Base Unit shown with optional 1/1 gastronorm pan 100 mm deep (sold separately)
 - Chip Warmer
 - Carving Station

SPECIFICATIONS

MODEL	DESCRIPTION	DIMENSIONS w x d x h (mm)	POWER watts	CURRENT amps	PACKED WEIGHT
MW10	Base Unit with optional 1/1 gastronorm pan 100 mm deep (sold separately)	395 x 640 x 475	785	3.4 amp	16 kg
MW10CW	Chip Warmer, with sloped tray	395 x 640 x 475	785	3.4 amp	16 kg
MW10CS	Carving Station, with 65mm deep, 1/1 gastranorm pan with 25mm deep perforated and spiked tray	395 x 640 x 475	785	3.4 amp	16 kg

Quartz Heat Lamp Assemblies



The stylish and functional Roband quartz heat lamp assemblies provide a balance of heat and light to front or back of house applications. They are manufactured from extruded anodised aluminium, with a number of different sizes and options available to suit various requirements. All models come with a standard mount bracket. Optional mount kit is also available. See page 27 for details.

Designed by Roband Australia, Easy Fit Globes feature a protective quartz outer layer that encapsulates the inner globe allowing for easier handling. This secondary layer of glass also protects food from globe breakages by capturing the shards and eliminating the need for a traditional glass window in the base of the cover. Lamp replacement can now be performed without the need for an electrician and takes only seconds.

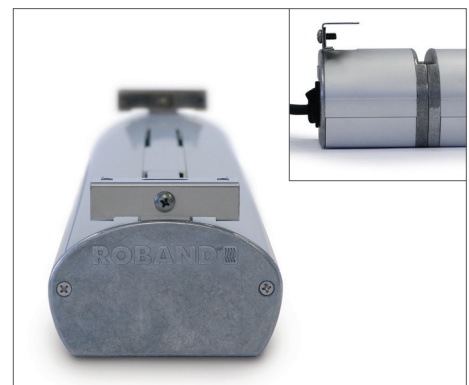
STANDARD MODELS

The standard heat lamp assemblies (e.g. HQ450E) come **with** a control box that houses the isolating on/off switch. They also feature a simple mounting system and come complete with a 10 amp plug and cord.

FABRICATOR MODELS

The heat lamp assemblies are also available **without** the control box and on/off switch (e.g. HUQ375E) so they can be connected to a remote switch setup. The removal of the control box shortens the length of the lamp assembly accordingly.

Standard mounting bracket available on standard and fabricator models



Quartz Heat Lamp Assemblies

SPECIFICATIONS - STANDARD MODELS (INCLUDES CONTROL BOX)

MODEL	INTERNAL LAMPS	MOUNT TYPE	CURRENT amps	POWER watts	LENGTH mm	LAMP CENTRES*	INCLUSIONS
HQ450E	1 lamp	Standard	1.5	350	450	N/A	Switch, plug & cord
HQ900E	2 lamps	Standard	3.0	700	900	400	Switch, plug & cord
HQ1200E	3 lamps	Standard	4.6	1050	1200	345	Switch, plug & cord
HQ1500E	4 lamps	Standard	6.1	1400	1500	345	Switch, plug & cord
HQ1800E	4 lamps	Standard	6.1	1400	1800	400	Switch, plug & cord
HQ2100E	5 lamps	Standard	7.6	1750	2100	400	Switch, plug & cord

*Length between centre of each lamp.



HQ1200E pictured

SPECIFICATIONS - FABRICATOR MODELS (NO CONTROL BOX)

MODEL	INTERNAL LAMPS	MOUNT TYPE	CURRENT amps	POWER watts	LENGTH mm	LAMP CENTRES*	INCLUSIONS
COMPLETE WITH A, N & E WIRE IN PTFE 1700 MM LENGTH FOR INSTALLATION TO YOUR OWN CONTROLLER							
HUQ375E	1 lamp	Standard	1.5	350	375	N/A	N/A
HUQ825E	2 lamps	Standard	3.0	700	825	400	N/A
HUQ1125E	3 lamps	Standard	4.6	1050	1125	345	N/A
HUQ1425E	4 lamps	Standard	6.1	1400	1425	345	N/A
HUQ1725E	4 lamps	Standard	6.1	1400	1725	400	N/A
HUQ2025E	5 lamps	Standard	7.6	1750	2025	400	N/A

*Length between centre of each lamp.

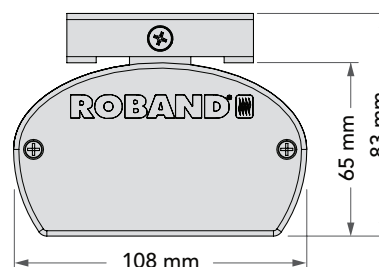


HUQ1125E pictured

Showing wire guard open for easy replacement of the globe



Dimensions for all standard quartz and fabricator quartz lamps (HQ & HUQ models). Brackets are removable.



Infra-Red Heating Assemblies



Roband infra-red heating assemblies are manufactured from an extruded anodized aluminium section, specifically designed to breathe. These units are designed for use at either front or back of house where more heat and no light is required. The heat is provided by a stainless steel element and an energy regulator is used on the standard units to precisely control the output, emitting a very even heat over the length of the warming area. All models come with a standard mount bracket. Optional mount kit is also available. See page 27 for details.

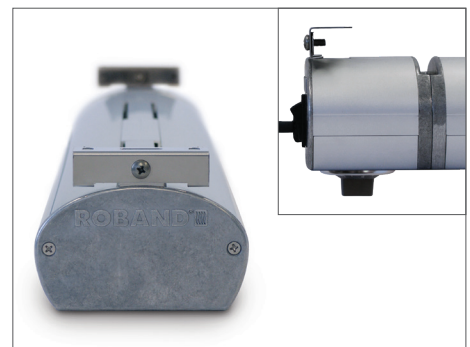
STANDARD MODELS

The standard infra-red heating assemblies (e.g. HE900) come **with** a control box that houses the isolating on/off switch and an energy regulator to control heat output. They also feature a simple mounting system and come complete with a 10 amp plug and cord.

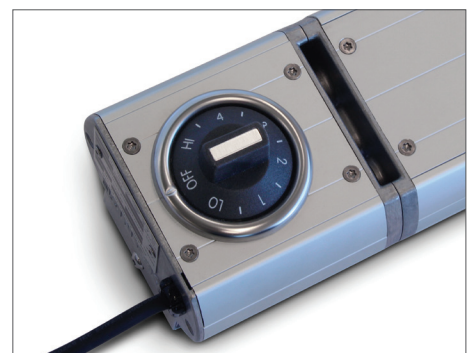
FABRICATOR MODELS

The infra-red heating assemblies are also available **without** the control box, energy regulator and on/off switch (e.g. HUE825) so they can be connected to a remote switch setup. The removal of the control box shortens the length of the assembly accordingly.

Standard mounting bracket available on standard and fabricator models



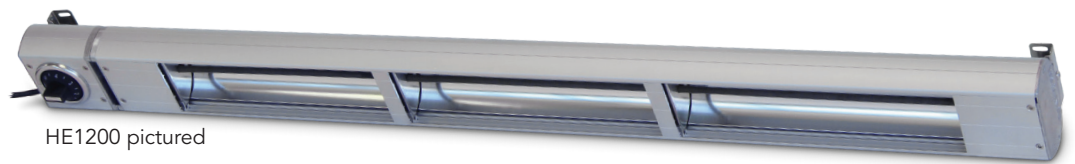
A variable control energy regulator is used to precisely control the output



Infra-Red Heating Assemblies

SPECIFICATIONS - STANDARD MODELS (INCLUDES CONTROL BOX)

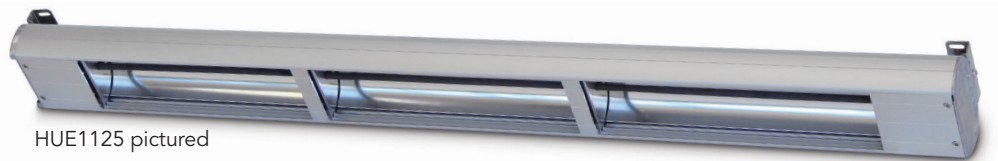
MODEL	DESCRIPTION	MOUNT TYPE	CURRENT amps	POWER watts	LENGTH mm	INCLUSIONS
HE900	1 element	Standard	3.9	900	900	Switch, plug & cord
HE1200	1 element	Standard	5.2	1200	1200	Switch, plug & cord
HE1500	1 element	Standard	6.5	1500	1500	Switch, plug & cord
HE1800	1 element	Standard	7.8	1800	1800	Switch, plug & cord



HE1200 pictured

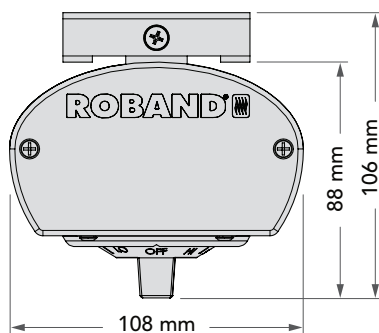
SPECIFICATIONS - FABRICATOR MODELS (NO CONTROL BOX)

MODEL	DESCRIPTION	MOUNT TYPE	CURRENT amps	POWER watts	LENGTH mm	INCLUSIONS
COMPLETE WITH A, N & E WIRE IN PTFE 1700 MM LENGTH FOR INSTALLATION TO YOUR OWN CONTROLLER						
HUE825	1 element	Standard	3.9	900	825	N/A
HUE1125	1 element	Standard	5.2	1200	1125	N/A
HUE1425	1 element	Standard	6.5	1500	1425	N/A
HUE1725	1 element	Standard	7.8	1800	1725	N/A

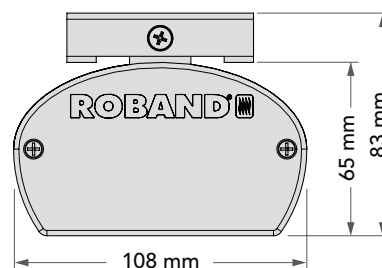


HUE1125 pictured

Dimensions for standard infra-red heating assemblies (HE models). Brackets are removable.

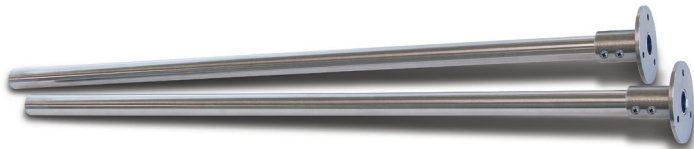


Dimensions for fabricator infra-red heating assemblies (HUE models). Brackets are removable.



Optional Mount Kit

Mount kit for Quartz, Infra-red series & Fluorescent assemblies. The kit includes 2 x 19 mm diameter round tubes, inserts and mounting brackets, with instructions for installation by an electrician. 600 mm tubes can be cut to the desired length.



HM600 pictured

SPECIFICATIONS

MODEL	DESCRIPTION	MOUNT TYPE	LENGTH (mm)
HM600	Mount kit for all quartz lamps, infra-red heat assemblies & fluorescent assemblies.	Round	600



Fabricator model with HM600 mount kit installed and shortened to the desired length

Modular Heat Lamp

The HL350 is a compact modular heat lamp manufactured from stainless steel, incorporating an easy fit 230 volt, 350 watt globe. The easy fit globes feature a protective quartz glass outer layer that encapsulates the inner globe allowing for safe handling. It is designed for use in custom fabricated installations as a modular component to be wired in parallel.

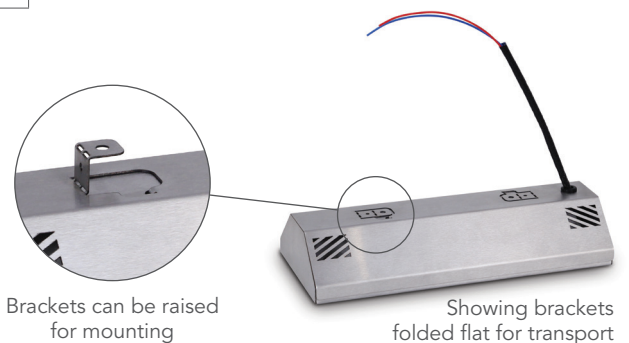
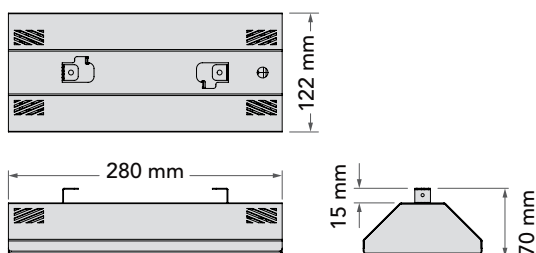
SPECIFICATIONS

MODEL	DESCRIPTION	VOLTS	POWER watts
COMPLETE WITH 300 MM PTFE FLYING LEADS (A + N) FOR INSTALLATION			
HL350	Modular lamp, single globe	230	350



HL350 pictured

DIMENSIONS



Brackets can be raised for mounting

Showing brackets folded flat for transport

Roband Rice Cookers

Roband Australia carefully sources a selection of commercial food service products that are manufactured overseas to meet the diverse needs of Australian food service establishments.

With Thai, Chinese, Japanese, Indian and other multi-cultural cuisines proving to be very popular with diners, Roband Australia recognises the need for reliable, efficient rice preparation.

We offer three types of rice preparation machines – three rice cookers, a rice cooker with a keep-warm function and a stand-alone rice warmer. Years of research and development has culminated in machines that deliver the very best quality of steamed rice.



RICE COOKERS

Available in three sizes providing 30, 39 or 55 cooked rice portions, the simple one-touch operation of the Roband rice cookers make them the ideal tool for rice production in busy establishments.

FEATURES

- Large 5.4 litre (30 portion), 7.2 litre (39 portion) or 10 litre (55 portion) capacity
- Easy one-touch operation
- Non-stick coated rice bowl
- Easy to use
- Auto shut-off
- Burn-proof pad (SW5400) or rice napkin (SW7200 & SW10000)
- Measuring cup and spoon included

SW10000 pictured



SW5400 pictured

SW7200 pictured

Cup and spoon included



See-through lid



Non-stick coated bowl has litre size graduations



Easy one-touch operation

SPECIFICATIONS

MODEL	SW5400	SW7200	SW10000
CAPACITY	5.4 litres	7.2 litres	10 litres
POWER	1680 watts	2300 watts	3450 watts
CURRENT	7.3 amps	10 amps	15 amps
CONNECTION	10 amp plug	10 amp plug	15 amp plug

Rice Cooker & Warmer

With a 35 portion capacity and the versatility to cook and keep large volumes of cooked rice warm, the Roband SW6000 is a must for busy food service establishments. The unit features simple one-touch operation plus automatic switch over to keep-warm function after rice has cooked. Additionally with a thermally insulated bowl and gasket sealed lid, set and forget rice preparation becomes a reality.

FEATURES

- Large 35 portion capacity
- Easy one-touch operation
- Solid stainless steel body and lid
- Non-stick coated rice bowl
- Keep warm function
- Auto shut-off
- Steam release valve
- Burn-proof pad
- Measuring cup and spoon included



SW6000 pictured

Cup and spoon included

SPECIFICATIONS

MODEL	SW6000
CAPACITY	6 litres
POWER	1680 watts
CURRENT	7.3 amps
CONNECTION	10 amp plug
DIMENSIONS	360 High x 470 Dia (mm)

RICE WARMER

The Roband Rice Warmer keeps rice that is already cooked, warm until it's served. The benefit of a stand alone rice warmer is that it frees up your rice cooker to enable further production of rice.

The SW9600 has a large 55 portion capacity so it's possible to have large volumes of rice available for your peak periods.

FEATURES

- Ideal solution for keeping large volumes of cooked rice warm (keeps rice warm only)
- 9.6 litre, 55 portion capacity
- Non-stick coated bowl
- Stainless steel body and lid
- Steam drainage system with catchment container for emptying



SPECIFICATIONS

MODEL	SW9600
CAPACITY	9.6 litres
POWER	100 watts
CURRENT	0.5 amps
CONNECTION	10 amp plug
DIMENSIONS	425 High x 430 Dia (mm)

Spoon included



SW9600 pictured

Operating Specifications and Disclaimers

Operating Specifications and Disclaimers

Dimensions detailed in this brochure are nominal only and may vary within tolerances from machine to machine.

Alterations to machine specifications may occur at any time due to ongoing research and development. Please check details with our offices for the latest information and specifications.

Performance specification evaluations are carried out under test conditions of either 230V 50Hz or 240V 50Hz. All standard Roband and Robatherm products are designed to run at 220-240V per phase, 50Hz. Equipment to suit other voltages can typically be manufactured to order. Variations to indicative machine performance may occur as a result of variances in the voltage delivered to an installed unit. Lower voltages will result in significant reductions in performance, particularly in radiant-heat toasters (conveyor toasters, griller toasters etc.). Should you have any concerns in this regard, please contact our office and one of our technicians will discuss the issue with you.



Precautionary note

We recommend that only demineralised water be used with our products, for both cleaning and (if applicable) operational purposes. Water with high mineral content (also referred to as "hard water") may lead to corrosion of the stainless steel surfaces over time. The durability and longevity of other components may also be adversely affected by water with a high mineral content.

Additionally we counsel against the use of spray applicators, chemical cleaners and water jets in the cleaning of electrical equipment. The use of direct spray applicators can promote moisture ingress inside electrical switches and cause electrical failures. Chemical cleaners with low PH levels, particularly chloride based cleaners can damage stainless steel, aluminium, plastics and polycarbonates and should be avoided to ensure the longevity of any equipment.



Operating Specifications and Disclaimers

Warranty

Our machines are manufactured to the highest standards and every care is taken to ensure that all completed goods leave our factory in perfect working order and in pristine condition.

All Roband and Robatherm machines are backed by a 12 month parts and labour warranty from the date of purchase. Additionally all units come with a comprehensive set of instructions detailing operation, safety and cleaning techniques. These instructions should be read in their entirety prior to operating any machine.

A written warranty also accompanies each machine, however details of the terms and conditions are available at any time on request. Typically, items such as glass, lamps and non-stick coating are excluded, but for full details please contact one of our offices.

Earth Leakage

Tubular heating elements (as used in most commercial heating equipment) may be subject to moisture absorption which can result in nuisance tripping of RCD's (Safety Switches). Although most cases can be solved easily by contacting our offices for advice, this is nevertheless an inherent characteristic of such elements and is not covered by warranty.

For further information regarding this or any other matter please contact our head office. Contact details can be found on the back cover of this brochure.



Roband Australia Pty Ltd

1 Inman Road,
Cromer, NSW 2099
Australia
Tel: +61 2 9971 1788
Fax: +61 2 9971 1336
Email: sales@roband.com.au

Roband (Europe) Ltd

Haygarth Park, Blaenau Ffestiniog
Gwynedd, North Wales
LL41 3PF, UK
Tel: +44 (0) 1766 830 456
Email: info@robandeuropa.com

All standard Roband and Robatherm products are designed to run at 220-240V per phase, 50Hz.

All dimensions are nominal only. All information contained in this brochure should serve as a guide only and is subject to change without notice due to constant research and development.

© 2018 Roband Australia Pty. Ltd. ACN 003 049 063 ABN 34 864 327 105

® is a registered trademark of Roband Australia Pty. Ltd.

Distributed in the UK by:

Metcalfe Catering Equipment Ltd

Haygarth Park
Blaenau Ffestiniog
Gwynedd
North Wales LL41 3PF
United Kingdom
t +44 (0)1766 830 456
f +44 (0)1766 831 170
e info@metcalfecatering.com
w www.metcalfecatering.com

