

USER MANUAL

Oracle



CAUTION: Read the instructions prior to using the equipment

*Cooking in itself is a science,
It's up to you to turn it into an art*

Dear customer,

Congratulations on having chosen **Oracle**.

The product you have purchased will allow you to combine speed and flavour from day one thanks to the innovative technological solutions it provides.

We recommend that you carefully read the warnings and advice included in this manual.

This will make it easier to use your new device and maintain its efficiency over time.

For any explanation, please do not hesitate to contact us at

tel. +39 0438 9110 - email: lainox@lainox.com

Technical support service



MODELS

STANDARD

ORACGS = ORACLE STANDARD Steel colour

ORACRS = ORACLE STANDARD Red colour

ORACBS = ORACLE STANDARD Black colour

BOOSTED

ORACGB = ORACLE BOOSTED Steel colour

ORACRB = ORACLE BOOSTED Red colour

ORACBB = ORACLE BOOSTED Black colour

Conformity

The conformity of the equipment refers to the complete equipment on delivery.

In the event of an expansion, modifications or connection of other functions, the user is responsible for the conformity of the modified equipment.

Observe the local and national rules and provisions for installation and operation of commercial cooking equipment.

INDEX

	Pag.
• GENERAL WARNINGS	6
• IMPORTANT SAFETY INSTRUCTIONS	10
• COOKING TIPS	12
• RECOMMENDATIONS FOR USE	13
• FEATURES	14
• BASIC KNOWLEDGE	15
• STARTING ORACLE	15
• PRIMARY ICONS	16
• COOKING MODE SELECTION	17
• HSO MODE - FCS AUTOMATIC COOKING	18
• HSO MODE - SETTING UP HSO MANUAL COOKING	19
• COMBI MODE - MCS AUTOMATIC COOKING	21
• COMBI MODE - SETTING UP COMBI MANUAL COOKING	22
• PROGRAMMING	24
• MY NABOOK	26
• CLOUD ACCESS CONFIGURATION	28
• USING THE CLOUD	34
• CARE AND CLEANING	38
• BEFORE CALLING SUPPORT	41
• WASTE MANAGEMENT AND ENVIRONMENTAL RESPECT	41
• SETTINGS	42

The manufacturer accepts no liability for any inaccuracies in this manual attributable to printing or copying errors. We reserve the right to modify our products as we deem fit, without impairing their basic features.

The reproduction or copying of any part of this manual by any means whatsoever is strictly forbidden unless authorized previously in writing by the manufacturer.

Copyright
Sending specific information about the products to third parties is not permitted. All rights, including those for translation and reproduction, are reserved.

- ORIGINAL INSTRUCTIONS -

GENERAL WARNINGS

Interventions that will become necessary over time, as well as special oven maintenance, must only be carried out by the manufacturer's personnel or by an authorised technical help service.

- **Read** the warnings in this manual carefully as they provide important information regarding safe use and maintenance.
- **Store this manual with care!**
- This device must only be used **as specifically intended**: to cook food. Any other use is to be considered incorrect and therefore, dangerous.
- Only properly trained service staff can use the device.
- This device can be used by children aged 8 years and over, and by persons with physical, sensorial or mental impairments, or scarce experience and knowledge, provided they are supervised or have been trained on how to use the device by a person responsible for their safety.
- Children must be supervised to ensure they do not play with the device.
- Cleaning and maintenance must not be entrusted to children unless they are supervised.
- Supervision is necessary during oven use.
- The equivalent sound pressure (A-weighted) is lower than 70dB(A).

GENERAL WARNINGS

- During operation, the oven has hot surfaces. **Take care!**
- **CAUTION!** During use, the oven's surfaces are hot as indicated by the stickers marked with the international symbol IEC60417 – 5041 . Take care!
- **CAUTION:** Hot steam may be released when the door is opened.
- When the device is used, use PPEs against heat.
- If the power cord is damaged, it must be replaced by the manufacturer, their help centre or by a person with similar qualifications, so as to prevent all risks.
- In the event of a fault or malfunction, turn the oven off immediately!
- **CAUTION:** Disconnect the power supply to the oven during cleaning and maintenance operations and when replacing components.
- **CAUTION:** The floor around the oven may be slippery!
- • Do not work on the machine using unsuitable systems for accessing the upper part (e.g. by using ladders or by climbing on the machine)

GENERAL WARNINGS

- **Treatment of chemical substances:**
- Use appropriate safety measures. Always refer to the data sheets on safety and to the labels on the product used.
- Use the PPEs recommended in the safety data sheets.
- The operator must work on the machine when wearing PPEs
- If technical assistance is required, all information indicated on the ID plate must be provided, **as well as detailed information about the fault** to make it easier for the support service to understand and resolve the problem.
- The oven power supply must have omnipolar mains switch with a minimum opening distance between the contacts of at least 3 mm per pole.
- The oven must be part of an equipotential bonding system. This connection is made by attaching a conductor with a nominal section of up to 10 mm² to the specific terminal, located on the rear of the oven, marked with the international symbol IEC60417 – 5021  .
The connection is made between all the adjacent devices in the room and the dispersion system in the building.
- This manual, can be downloaded in various languages using the QR-codes shown on the specifications plate.

GENERAL WARNINGS

Electrical safety and advice on additional electrical protection

- Commercial kitchens and catering areas are environments in which electrical appliances can be placed near liquids, or operate in humid conditions or where the limitation of movement for installation and assistance is evident.
- Installation and periodic inspection of the appliances must only be carried out by a qualified, experienced and competent electrician; in addition, the appliances must be connected to an adequate power supply according to the load, as reported on the label containing the appliance data.
- The installation and electrical connections must meet the necessary requirements, in accordance with the local regulations on electrical wiring and with the guidelines for electrical safety.
- **The following is recommended:**
- Ensure additional electrical protection with the use of a differential switch (RCD).
- Make sure that fixed wiring appliances include a local disconnect switch to which they can be connected and that this is easily accessible for shutdown and safe isolation. The disconnect switch must meet the requirements specified in the IEC 60947 standard.

IMPORTANT SAFETY INSTRUCTIONS

RECOGNIZE THIS SYMBOL AS A SAFETY MESSAGE

WARNING

When using electrical equipment, basic safety precautions should be followed to reduce the risk of burns, electrical shock, fire, or injury to persons including the following.

1. READ all instructions before using equipment.
2. READ AND FOLLOW the specific "PRECAUTIONS TO AVOID POSSIBLE EXPOSURE TO EXCESSIVE MICROWAVE ENERGY" on this page.
3. Install or locate this equipment ONLY in accordance with the installation instructions in this manual.
4. Liquids or other foods, must not be heated in sealed containers since they are liable to explode.
5. Eggs in their shell and whole hard-boiled eggs should not be heated in microwave ovens since they may explode even after microwave heating has ended.
6. Failure to maintain the oven in a clean condition could lead to deterioration of the surface that could adversely affect the life of the appliance and possibly result in a hazardous situation;
7. See door cleaning instructions on page 41 of this product safety manual.
8. Do not heat baby bottles in oven. Baby food jars must be open when heated and contents stirred or shaken before consumption, in order to avoid burns.
9. DO NOT operate this equipment if it has a damaged cord or plug, if it is not working properly, or if it has been damaged or dropped.
10. This equipment, including power cord, must be serviced ONLY by qualified service personnel. Special tools are required to service equipment. Contact nearest authorized service facility for examination, repair, or adjustment.
11. DO NOT cover or block vents or other openings on equipment.
12. DO NOT store this equipment outdoors. DO NOT use this product near water, for example, near a kitchen sink, in a damp basement, swimming pool, or similar location.
13. DO NOT immerse cord or plug in water.
14. Keep cord AWAY from HEATED surfaces.
15. DO NOT let cord hang over edge of table or counter.

PRECAUTIONS TO AVOID POSSIBLE EXPOSURE TO EXCESSIVE MICROWAVE ENERGY

1. **DO NOT** attempt to operate this oven with the door open since open door operation can result in harmful exposure to microwave energy.
It is important not to disable or tamper with the safety interlocks.
2. **DO NOT** place any object between the oven front face and the door to allow dirt or cleaner residue to accumulate on sealing surfaces.
3. **DO NOT** operate the oven if it is damaged. It is particularly important that the oven door close properly and that there is no damage to the:
 1. door (bent)
 2. hinges and latches (broken or loosened)
 3. door seals and sealing surfaces.
- D. The oven should not be adjusted or repaired by anyone except properly qualified service personnel.

IMPORTANT SAFETY INSTRUCTIONS

WARNING

To avoid risk of fire in the oven cavity:

- a. Do not overcook food. Carefully attend oven when paper, plastic, or other combustible materials are placed inside the oven, due to the possibility of ignition.
- b. Remove wire twist-ties from paper or plastic bags before placing bag in oven.
- c. If materials inside the oven ignite, keep oven door CLOSED, turn oven off and disconnect the power cord, or shut off power at the fuse or circuit breaker panel.
- d. Do not use the cavity for storage. DO NOT leave paper products, cooking utensils, or food in the cavity when not in use.
- e. Do not add alcohol when cooking!

WARNING

Liquids such as water, coffee or tea can be overheated beyond boiling point without appearing to be boiling due to surface tension of the liquid. Visible bubbling or boiling when the container is removed from the microwave oven is not always present. THIS COULD RESULT IN VERY HOT LIQUIDS SUDDENLY BOILING OVER WHEN A SPOON OR OTHER UTENSIL IS INSERTED INTO THE LIQUID. To reduce the risk of injury to persons:

- i. Do not overheat the liquid.
- ii. Stir the liquid both before and halfway through heating it.
- iii. Do not use straight-sided containers with narrow necks.
- iv. After heating, allow the container to stand in the microwave oven for a short time before removing the container.
- v. Use extreme care when inserting a spoon or other utensil into the container.

WARNING

To avoid personal injury or property damage, observe the following:

1. Do not deep fat fry in oven. Fat could overheat and be hazardous to handle.
2. Do not cook or reheat eggs in shell or with an unbroken yolk using microwave energy. Pressure may build up and make them explode. Pierce yolk with fork or knife before cooking.
3. Pierce skin of potatoes, tomatoes, and similar foods before cooking with microwave energy. When skin is pierced, steam escapes evenly.
4. Do not operate equipment when the oven cavity is empty.
5. Microwave popcorn should not be popped in oven.
6. Do not use regular cooking thermometers in oven. Most cooking thermometers contain mercury and may cause an electrical arc, malfunction, or damage to oven.
7. Do not use metal utensils in oven.
8. Do not use aluminium foil in oven
9. Never use paper, plastic or other combustible materials that are not intended for cooking.
10. When cooking with paper, plastic or other combustible materials, follow manufacturer's recommendations on product use.
11. Do not use paper towels which contain nylon or other synthetic fibres. Heated synthetics could melt and cause paper to ignite.
12. Do not heat sealed containers or plastic bags in oven. Food or liquid could expand quickly and cause container or bag to break. Pierce or open container or bag before heating.
13. To avoid pacemaker malfunction, consult physician or pacemaker manufacturer about effects of microwave energy on pacemaker.
14. An authorized service technician MUST inspect equipment annually. Record all inspections and repairs for future reference.

COOKING TIPS

1. Avoid using silicone pans and accessories.
2. Make use of the accessories supplied or available in the catalogue.
3. Line pans with parchment paper for easy removal of food after heating and cleaning.
4. Muffin tins are useful for individual cakes and brownies. Spray with cooking spray prior to cooking for easy removal of food after heating.
5. Frequent cleaning prevents unnecessary build-up that may affect the oven performance.
6. Use the manufacturer's recommended cleaner or another cleaner that does NOT contain ammonia, phosphates, chlorine, sodium hydroxide or potassium hydroxide, as this may damage basic oven components and void the applicable warranty. For optimal results, use the OWDC inner door protection and the Oracle Washable Box; replace them in case of excessive delamination or wear.
7. Items will be hot when finished cooking. Use oven mitt, tongs or pizza paddle to safely remove items from oven.

When to use Stage Cooking

Stage cooking enables you to use up to four different cooking cycles or stages to be used consecutively without repeated input from the user. Stage cooking can be set to defrost food initially, then cook it, and lastly, keep the food warm until serving time.

Note: The total cooking time for all the stages cannot exceed 60 minutes.

Example:

PIZZA (FROZEN)

Total Cooking Time: 2:00

Temperature: 270 °C (520 °F)

	Stage 1	Stage 2	Stage 3
Time	50"	50"	20"
Microwave	80%	30%	0%
Fan	100%	100%	100%

RECOMMENDATIONS FOR USE

First ignition settings

Before using a new oven for the first time:

remove the Oracle Washable Box and the OWDC inner door protection (possibly supplied or purchased separately), clean the oven using the OSOCL detergent with a damp cloth and rinse; spray the OSOPR oven protection product on a damp cloth and wipe all surfaces inside the oven. Do not remove the OSPPR oven protective product. Insert the Oracle Washable Box, the baking surface and the OWDC inner door protection.

Bring the oven to 300°C (572°F) for 30 minutes in convection mode to remove all odours normally found in new ovens. Do not activate the microwave function.

The first time it is switched on, a window appears on the screen prompting setting of the language.

Scroll inside the window and select the desired language (the default language is English).

After selecting the language, select “do not show this message again”. The next time the oven is switched on, there will no longer be any prompts to select the language.

On the home screen, two icons appear below the power-up one. The one on the right refers to the user manual (which can be downloaded using the QR-code on the specifications plate) while the one on the left refers to the settings.

For the next steps it is recommended to read the user manual.

Switching off the oven

At the end of the day, turn off the oven by pressing the green icon on the screen. The oven will begin to cool.

The oven fan will continue to turn to cool the oven.

The screen will show “Cooling” which will remain present until the oven temperature is below 60°C (140°F)

WARNING: To avoid damaging the convection motor, do not turn off the power by unplugging the unit or turning off the power switch until the fan has stopped.

FEATURES

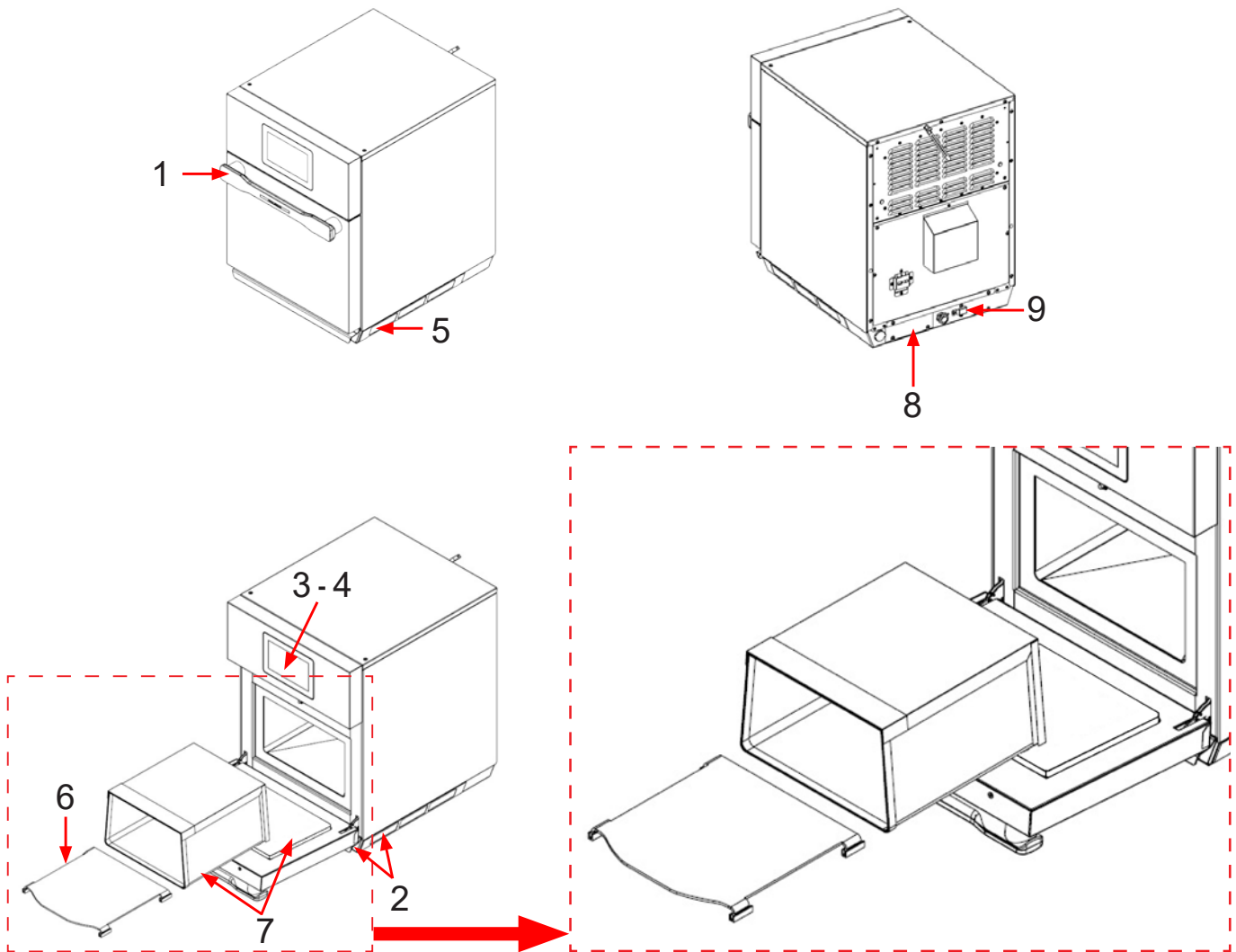

1. Door handle

Ergonomic design for one-handed operation.

2. Air filters

The oven is equipped with 3 magnetic air filters: two located on the lower sides of the oven and one under the door

3. Touchscreen display

The display is equipped with a user interface. Use to set the time, program and to operate the oven.

4. ON / OFF button on the display

Use to turn on the oven.

5. USB port

The oven is equipped with a USB port, located behind the magnetic filter on the right side of the oven. Use with standard USB drives.

6. Smooth cooking plate accessory

The oven is equipped with a removable smooth cooking plate which contributes to the browning and toasting of bread, pizzas and other foods.

7. ORACLE WASHABLE BOX and OWDC

The oven can be equipped with an "ORACLE WASHABLE BOX" and an OWDC inner door protection, which can be removed and washed, making it easier to keep the oven clean, and replaceable in case of excessive delamination and wear.

8. Characteristics Plate and serial number positioned on the back of the oven

9. Safety thermal reset button

The oven is equipped with an emergency power reset button.

To access the reset button:

- a) Unscrew the button protection.
- b) Press and press the button to reset the oven

BASIC KNOWLEDGE

You can interact with ORACLE using your fingertips to touch, drag and scroll the objects on the touchscreen.

Control the touchscreen using the following actions:

- **Touch**

Touch once to select or start a recipe.

- **Press and hold**

Hold an element pressed for more than 2 seconds to select one of the available options.

- **Scroll**

Drag up or down to scroll.

On some screens you can also scroll from side to side.

By scrolling with your fingertips you can also display the content of the screen without selecting or activating other functions.

- **Drag**

Touch an element and move it to a new position.

STARTING ORACLE

When the appliance is electrically powered, the display shows the following screen.

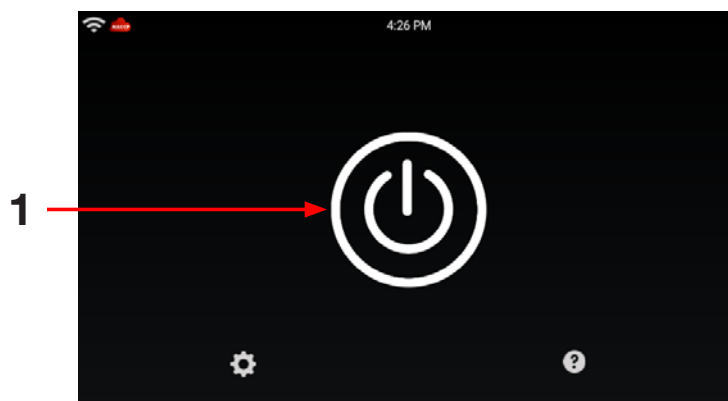

To start Oracle press the button (1), then select the desired cooking mode.

PRIMARY ICONS

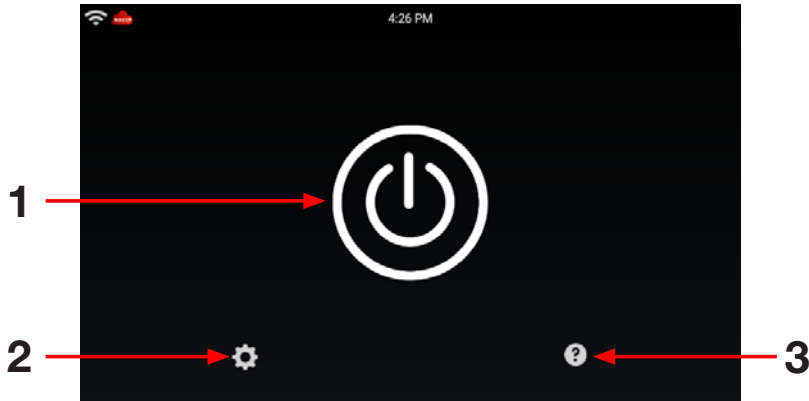

1 - ON/OFF button Pulsante di accensione/spegnimento

2 - Settings

3 - User Manual

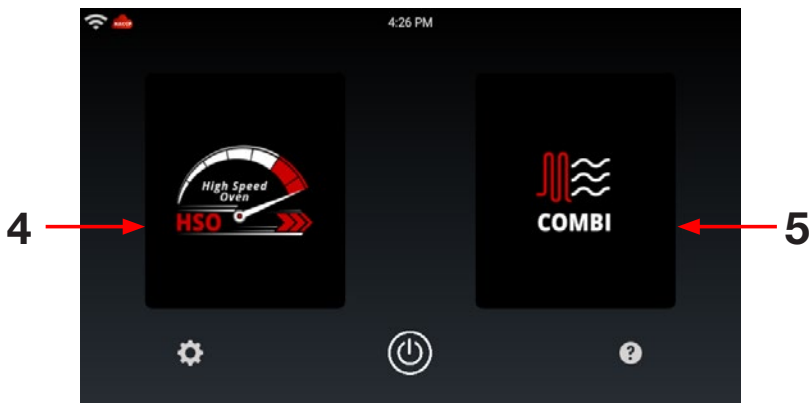

4 - HSO Cooking mode

5 - Combi Cooking mode

6 - FCS Automatic Cooking

7 - Cooking folder

8 - MCS Automatic Cooking

9 - Manual mode

10 - Preheating

11 - Programming mode

12 - My Nabook
Recipe archive present in Oracle

14 - Cloud

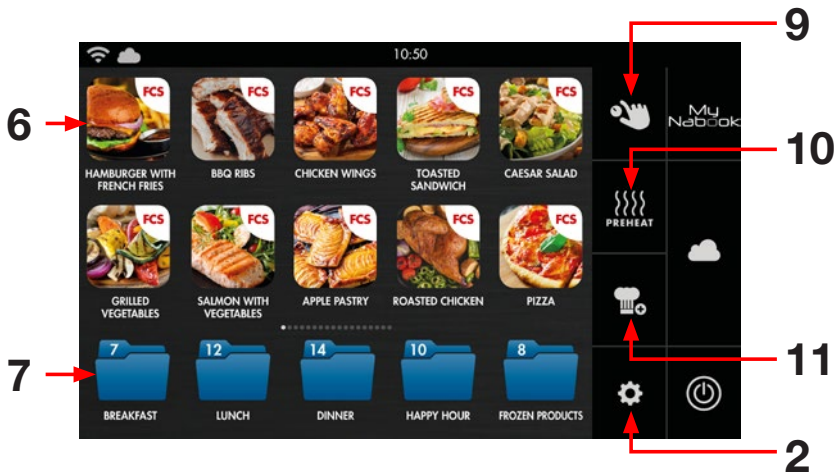

COOKING MODE SELECTION

The Oracle oven allows you to work in two modes: HSO (High Speed Oven) and COMBI.



In HSO mode, the oven with the combined action of microwaves and hot air allows you to offer your customers ready meals in a few seconds.



In COMBI mode, the oven allows you to use the convection, microwave or combined Convection + microwave cooking mode for maximum flexibility in the mise en place.

HSO MODE

FCS AUTOMATIC COOKING



Select the **FCS** icon to begin “one touch” cooking, starting with predefined settings.

Oracle starts and when it reaches the set temperature, a popup appears instructing you to insert the product.



Press “INFO” to view additional information regarding the recipe (Context, Ingredients, Process, Accessories and Presentation).



Press “Table” to view all the cooking phases.

At the end of cooking, a buzzer sounds and a popup signals that cooking has completed.

HSO MODE

SETTING UP HSO MANUAL COOKING



In HSO mode, press the icon to set a Manual cooking.

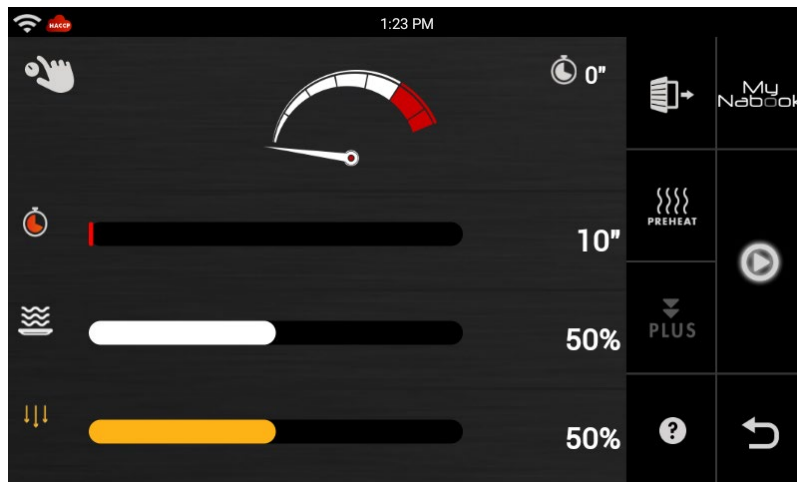

The following cooking parameters can be customised:

- Time



This is set through the touchscreen. Scrolling to the right increases the value and scrolling to the left decreases it. To make an accurate setting, press [+] to increase the value of a unit or [-] to decrease the value of a unit.

HSO MODE

SETTING UP HSO MANUAL COOKING

- Microwave



This is set through the touchscreen. Scrolling to the right increases the value and scrolling to the left decreases it. To make an accurate setting, press [+] to increase the value of a unit or [-] to decrease the value of a unit.

- Impingement



This is set through the touchscreen. Scrolling to the right increases the value and scrolling to the left decreases it. To make an accurate setting, press [+] to increase the value of a unit or [-] to decrease the value of a unit.



Once the desired values have been set, press the **PLAY** button to start cooking.

At the end of cooking, a buzzer sounds and a popup signals that cooking has completed.

COMBI MODE

MCS AUTOMATIC COOKING



Select the **MCS** icon to begin “one touch” cooking, starting with predefined settings.

Oracle starts and when it reaches the set temperature, a popup appears instructing you to insert the product.

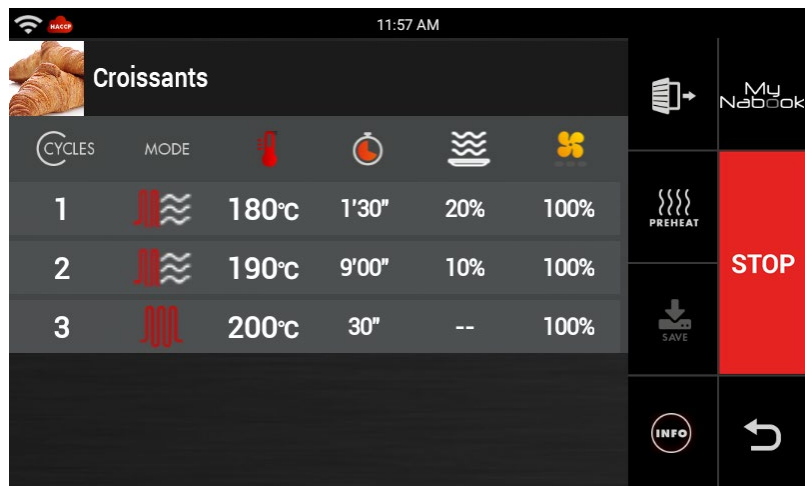

Press “INFO” to view additional information regarding the recipe (Context, Ingredients, Process, Accessories and Presentation)..

At the end of cooking, a buzzer sounds and a popup signals that cooking has completed.

COMBI MODE

SETTING UP COMBI MANUAL COOKING



In COMBI mode, press the icon to set a Manual cooking.

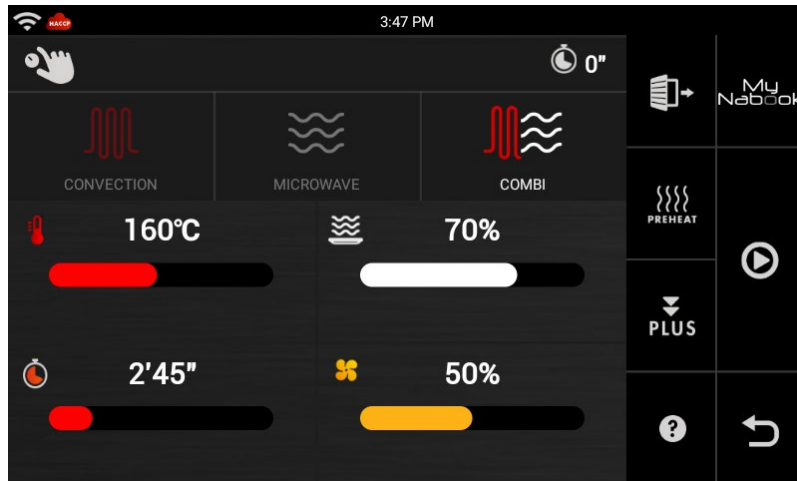

Select a cooking mode.

The cooking modes are: Convection, Microwave and COMBI (Convection + microwave).

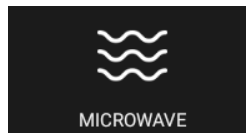
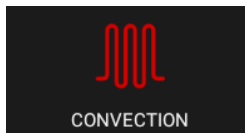

Once the cooking mode has been set, the following cooking parameters can be customised:

• Temperature



This is set through the touchscreen. Scrolling to the right increases the value and scrolling to the left decreases it. To make an accurate setting, press [+] to increase the value of a unit or [-] to decrease the value of a unit.

COMBI MODE

SETTING UP COMBI MANUAL COOKING

- Time

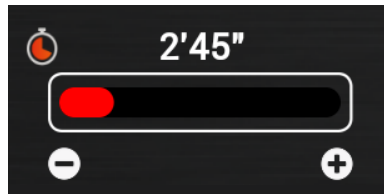

This is set through the touchscreen. Scrolling to the right increases the value and scrolling to the left decreases it. To make an accurate setting, press [+] to increase the value of a unit or [-] to decrease the value of a unit.

- Microwave

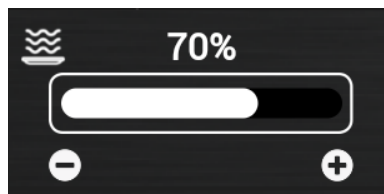

This is set through the touchscreen. Scrolling to the right increases the value and scrolling to the left decreases it. To make an accurate setting, press [+] to increase the value of a unit or [-] to decrease the value of a unit.

- Ventilation

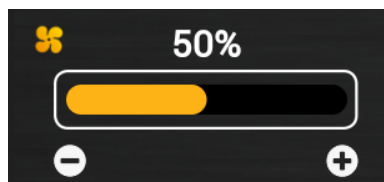

This is set through the touchscreen. Scrolling to the right increases the value and scrolling to the left decreases it. To make an accurate setting, press [+] to increase the value of a unit or [-] to decrease the value of a unit.



Once the desired values have been set, press the **PLAY** button to start cooking.

At the end of cooking, a buzzer sounds and a popup signals that cooking has completed.

PROGRAMMING



Press the icon to create a new Manual Program, Multi-level program or modify an existing program.

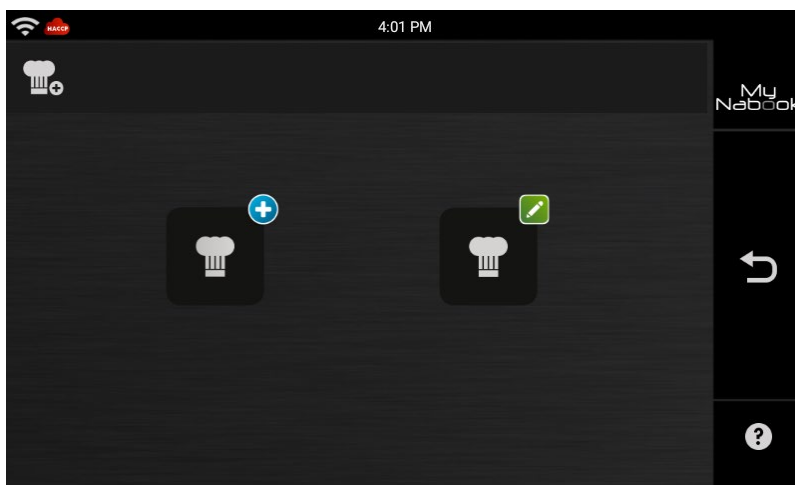

SETTING UP A MANUAL PROGRAM



Press the icon to create a new Manual Program.

Proceed as if setting up Manual cooking.



To add a cycle, press "+" and set the subsequent cycles as with manual cooking until the program is completed.

MODIFYING AN EXISTING PROGRAM



Press the icon to modify an existing program.

Search for the program to be modifying by keying in at least part of the name of the program.



Select one of the results to proceed with the change.

PROGRAMMING

SAVING A PROGRAM



Press the icon to access the screen to save the program.

- Set the name of the program (minimum 3 characters)



- Set the program icon by pressing the icon and selecting one from among those proposed.

- Set the additional information:

- **Context:** Information regarding the description of the recipe, season, origin and history of the dish.

Ingredients: The ingredients and quantities listed in detail.

- **Instructions:** Detailed information on how to create the recipe, step by step.

- **Accessories:** Detailed information on how to create the recipe, step by step.

- **Presentation:** The image of the presentation of the finished dish.

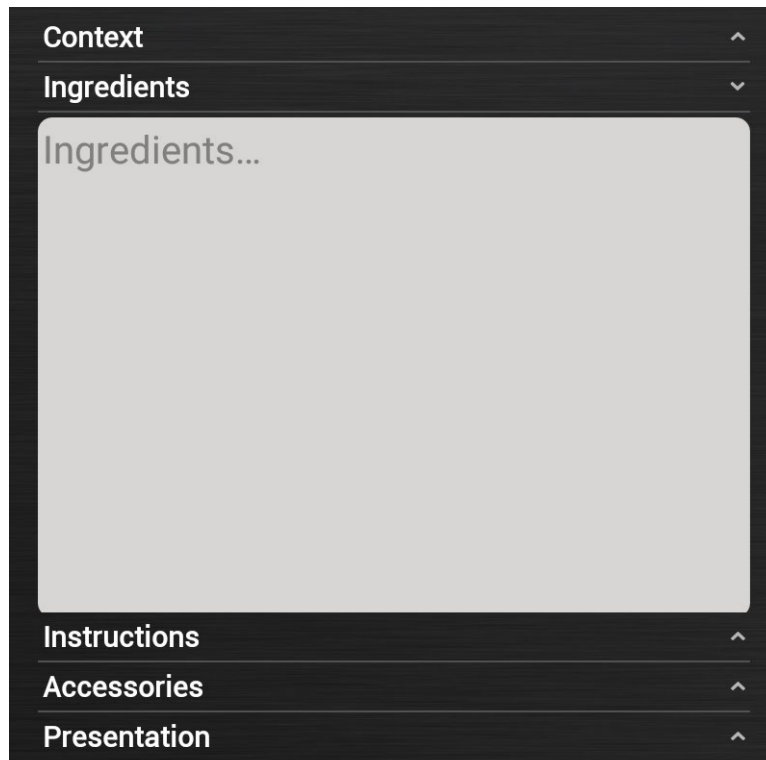

The screenshot shows a dark-themed interface with several sections. At the top, 'Context' is expanded with an upward arrow. Below it, 'Ingredients' is collapsed with a downward arrow. A large, light gray rectangular area is visible, containing the text 'Ingredients...'. At the bottom, 'Instructions', 'Accessories', and 'Presentation' are listed, each with an upward arrow indicating they are collapsed.



- Press the "**SAVE**" icon to save the program.

MY NABOOK



Press the icon to access **My Nabook**.



My Nabook is the archive of all of the Oracle cooking programs.

From **My Nabook** you can manage all of the programs contained in Oracle.

By selecting a program you can see all of the information regarding the program and the related cooking phases.

Example:

PHASES					
CYCLES	MODE				
1	☞☞☞	--	1'00"	100%	100%
2	☞☞☞	--	30"	50%	100%
3	☞☞☞	--	40"	0%	100%

MY NABOOK

SEARCH PROGRAMS

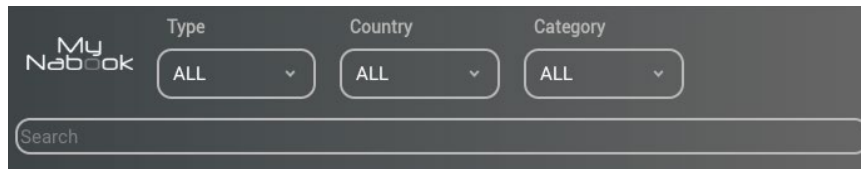

In **My Nabook** I can look up programs by:

- **Name:** by keying the text to look for in the appropriate field.
- **Type:** by choosing from among the available values (for example: Pasta, Meat, Vegetables, Fish, Smokegrill, Night Cooking, Pastries, etc.).
- **Country:** by choosing from among the available values (for example: International, Italy, Germany, Austria, France, Russia, etc.).
- **Category:** by choosing from among the available values (for example: Quick cooking, Grill cooking, Finger Food, Fast Food, Happy Hour, etc.).

PROGRAMS ADDED TO HOME



To add a program to the Oracle home screen, drag the program to the "**HOME**" icon.

The program will now be available in the Oracle home screen.

NOTE:

Deleting a program from the Oracle home screen does not remove it from **My Nabook**. All of the programs in the Oracle home screen are Links to **My Nabook programs**.

CLOUD ACCESS CONFIGURATION

INTRODUCTION:

The requirements to access the **Oracle Cloud** functionality are as follows:

Wi-Fi connection with internet access

Account registration to access the Cloud.

VERIFY THE SOFTWARE VERSION



Press the icon to access the Oracle settings.



CLOUD ACCESS CONFIGURATION

ACTIVATION OF THE WI-FI CONNECTION



Press the icon to access the Oracle settings.

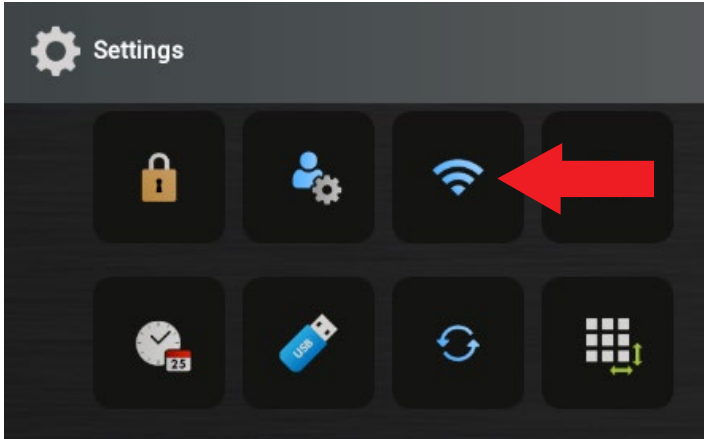

Press the icon “**Wi-Fi Settings**” to check the activation and availability of the Wi-Fi connection.



Press the icon **(1)** setting it to **ON** to activate the Oracle Wi-Fi connection

Select a Wi-Fi network **(2)** displayed on the screen.

When there are similar networks, choose the one with the best signal.

Enter the Wi-Fi password if required.

Press the cone **(3)** to test the connection and check the proper operation.

After having selected the Wi-Fi network, press the back icon **(4)**.

CLOUD ACCESS CONFIGURATION

REGISTERING THE CLOUD ACCOUNT



Press the icon to access the Oracle settings.

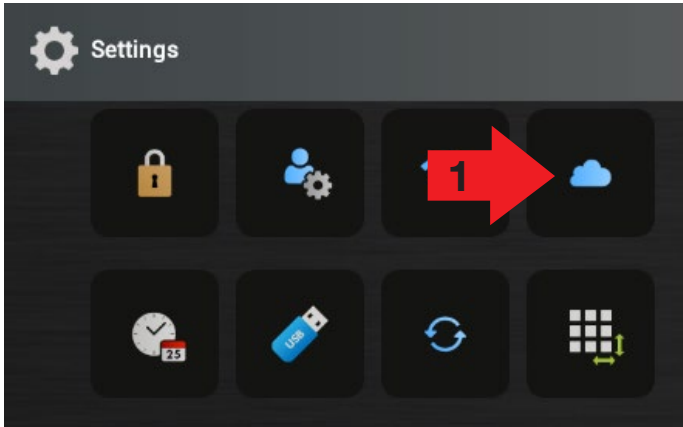

Press the icon “**Cloud Settings**” (1) to access the Registration/Login to the Oracle Cloud screen.

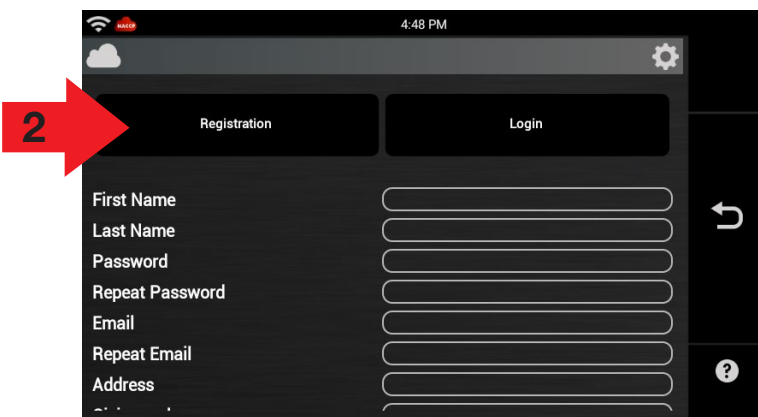

Select the “**Registration**” icon (2) and enter the information required:

Name
Last Name
Username
Password
Re-enter Password
Email
Re-enter Email
City
Country
Address
Postal Code
Telephone

Once all of the data has been entered, press OK (3).

NOTES:

- First and last name must have at least 2 characters.
- Username and password must have at least 6 characters.

CLOUD ACCESS CONFIGURATION

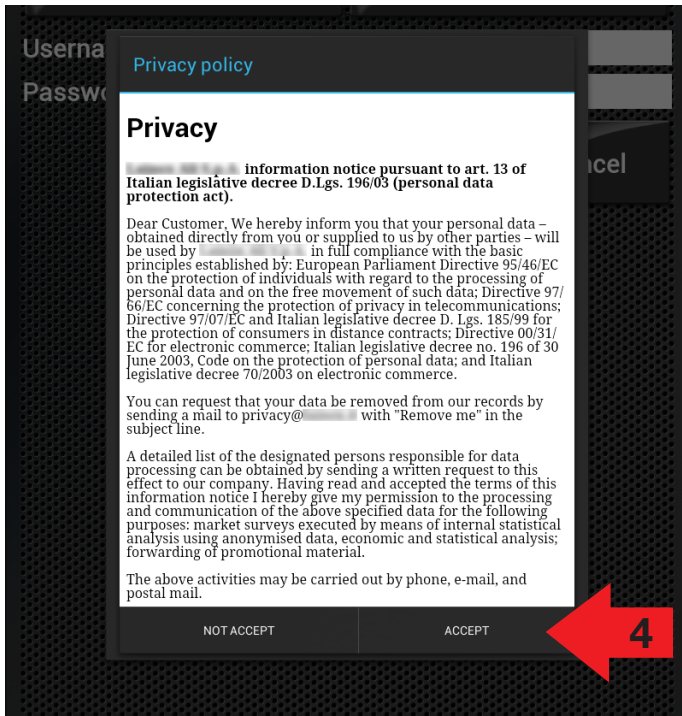

Read the Privacy terms and select the icon **"ACCEPT"** (4) to continue with the registration.

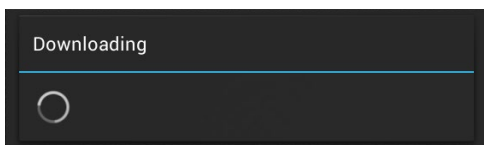

Wait a few seconds for this window to appear.

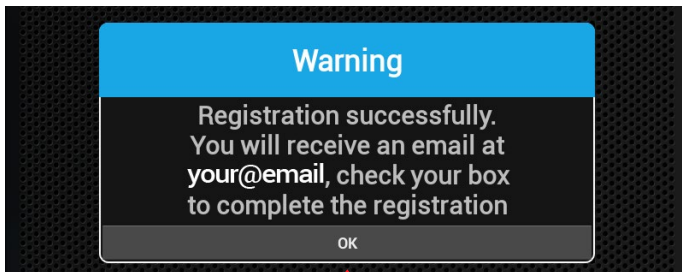

A message will appear on the display indicating that registration is complete. Press **OK** (5).

You will receive an Email at the address given during registration including the link to complete the registration.

CLOUD ACCESS CONFIGURATION

Click on the link in the Email (6) to complete the registration.

Verify email



o No Reply Nabookplus

A: o [redacted]

Someone has created a Nabookstag account with this email address. If this was you, click the link below to verify your email address

[Link to e-mail address verification](#)



This link will expire within 5 minutes.

If you didn't create this account, just ignore this message.

CLOUD ACCESS CONFIGURATION

LOGIN TO THE CLOUD ACCOUNT



Press the icon to access the Oracle settings.

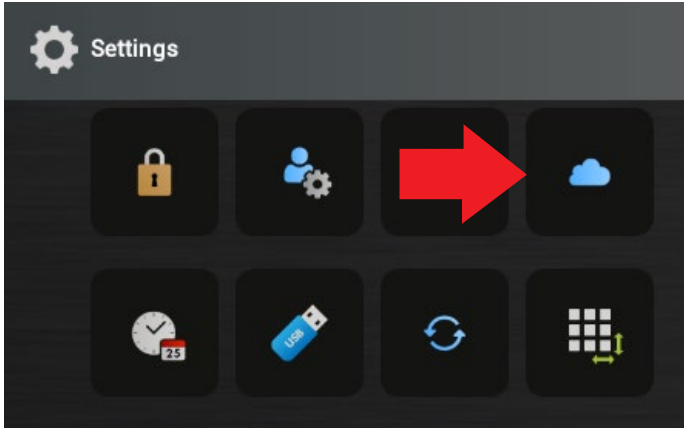

Press the icon “**Cloud Settings**” to access the Registration/Login to the Oracle Cloud screen.

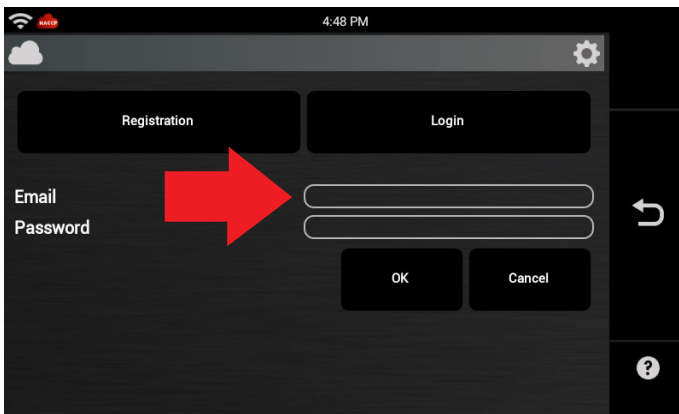

Enter the “Username” and “Password” given during registration and press OK.

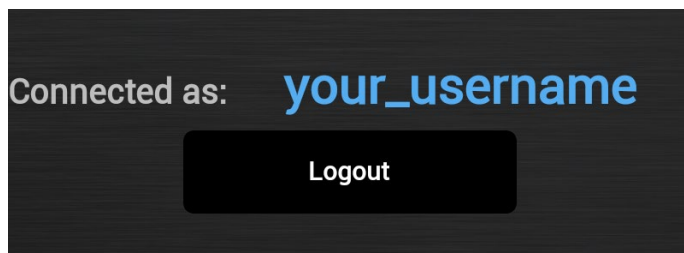

After a few seconds the following screen will appear indicating that connection has been made to the Oracle Cloud.

USING THE CLOUD

DOWNLOAD RECIPES



Make sure that the symbols for the Wi-Fi and CLOUD connection appear in the upper left.



Press the CLOUD key

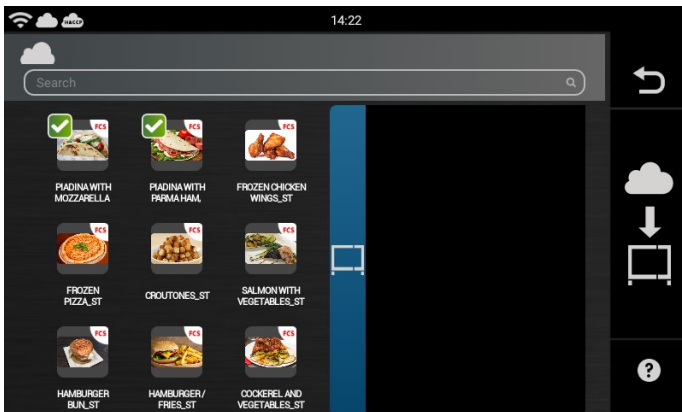

The display will show the recipes available in the CLOUD.



The recipes marked in green are already present in your Oracle.

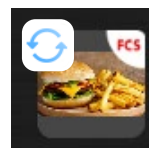

The recipes with two blue arrows that rotate are more up to date than those in your Oracle.

Click on the recipe to display the information regarding cooking modes, times, etc.

USING THE CLOUD



To import the recipes in Oracle, select the recipe to download and pull the recipe icon to the dedicated area.

Press the icon “Download to Oracle” to start the recipe download.

USING THE CLOUD

SOFTWARE UPDATE

Oracle can be constantly updated to the latest available Software version.



Press the icon to access the Oracle settings.

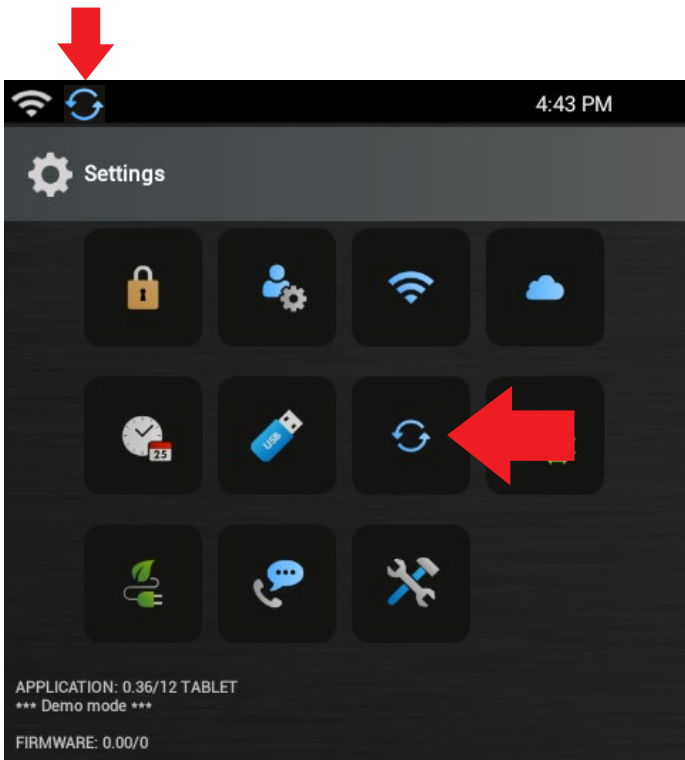

If there is a Software update available there will be an icon in the notifications area in the top left.

Press the icon “**Software Update**” to access the update screen.

USING THE CLOUD

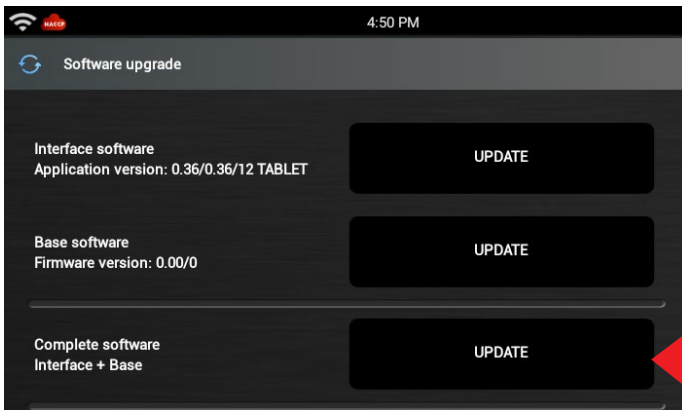

Only for updates with USB

Select "Verify updates"



Oracle will automatically look for any updates in the Cloud.



If available, press the update icon.



If there is no update available, press the "Back" icon to return to the Home page.

CARE AND CLEANING

Follow the recommendations below and on the following page for proper maintenance of the ORACLE oven.

 The use of caustic cleaning products or those containing ammonia, phosphates, chlorine, sodium or potassium hydroxide (caustic soda) can damage essential oven parts. Do not use water pressure type cleaning systems.

WARNING: Do not use pressure or steam cleaning systems.

Use of unapproved cleaning agents will void the terms of the warranty.

Recommended cleaning supplies:

Damp cloth, plastic abrasive scouring pad, OSOCL oven cleaner, OSOPR oven protector, mild dish detergent, rubber gloves, protective glasses, microfibre cloth

If the **Oracle Washable Box** and the **OWDC** inner door protection are used, they must be washed daily according to the following instructions:

- Remove larger food and grease residues with a damp cloth.
- Hand wash with warm water and using a non-corrosive detergent or a detergent that does not contain ammonia, phosphates, chlorine, potassium or sodium hydroxide (caustic soda). Do not use sharp tools.
- Leave to dry at room temperature.
- The **Oracle Washable Box** and the **OWDC** inner door protection must be replaced if there are signs of delamination or significant wear.

If the oven is fitted on feet, the surface beneath the oven must be cleaned regularly.

Recommended procedures:

- Clean the oven daily or as required.
- Clean when the oven is cold
- Clean with cold tools and accessories.
- Use a non-corrosive cleaner.
- Wear protective gloves and goggles when cleaning.
- Always use the recommended cleaning products: damp cloth, abrasive sponge, OSOCL oven cleaner and OSOPR oven protection.
- Remove the food and its residues from the oven at the end of the cooking cycle, do not scratch or scrape the inner surfaces of the oven and do not damage the inner side plates of the oven.
- Use only accessories suitable for high temperature ovens and microwaves.
- Wash the cooking plate with warm soapy water and allow to air dry (dishwasher safe, washing and use can result in a change of colour).
- Wash the Oracle Washable Box and the OWDC inner door protection with warm soapy water and allow them to air dry (dishwasher safe, washing and use may cause the colour to change).
- Place pans in the centre of the grille, not in contact with the oven walls.
- Clean the door and other surfaces with a clean cloth, sponge or nylon pad using a solution of warm water and mild detergent.
- Clean the display with a dry or damp microfibre cloth.
- Weekly or as required remove all 3 magnetic air filters located along the base on the front and sides of the oven. Wash the filters in a solution of warm water and mild detergent (they can be washed in the dishwasher).
- Rinse thoroughly and dry carefully. Place the clean filters on the base and sides of the oven.

WARNING

Wear protective gloves and protective glasses when cleaning the oven.

To prevent burns, handle utensils, accessories, and door with care. Allow oven, utensils, and accessories to cool before cleaning. Oven, utensils, and accessories become hot during operation

Failure to maintain the oven in a clean condition could lead to deterioration of the surface that could adversely affect the life of the appliance and possibly result in a hazardous situation.

CARE AND CLEANING

Recommended procedures

DO NOT use harsh chemicals.

DO NOT spray liquids on the screen.

DO NOT accelerate cooling of the oven by using water or ice.

DO NOT use cleaning products that are corrosive or that contain ammonia, phosphates, chlorine, potassium or sodium hydroxide (caustic soda).

DO NOT use pressure cleaning systems.

DO NOT spray cleaner into the holes.

DO NOT use abrasive sponges to clean the cover of the upper surface of the cooking compartment

DO NOT cook food wrapped in plastic wrapping.

DO NOT use the oven if the air filters are not in place.

DO NOT operate the oven empty in microwave mode.

DO NOT apply weights greater than 5 kg or lean against the open door. Risk of damage to or overturning of the oven.

- Below is the table of the scheduled and preventive maintenance plan.

COMPONENT	FREQUENCY	ACTION
Oven and accessories	Daily	Wash the oven and accessories daily or as required according to the instructions in the manual.
Inlet air filters	Weekly	clean the magnetic air filters with water and neutral detergent
Internal air filter	100,000 cycles	When changing the magnetrons, clean the air expulsion grille in the back of the oven.
Electric contactor	100,000 cycles	Replace the component with original spare parts. The oven contains an internal counter that stores the number of activations. At the end of the recommended cycles, it will show a maintenance recommendation notification.

CARE AND CLEANING

DAILY CLEANING:

1. PREPARE OVEN	<ol style="list-style-type: none"> Shut oven off by pressing ON/OFF button. The fan will run for a few minutes to cool the oven interior faster. Let the oven interior reach room temperature before cleaning. Note: <i>To accelerate cool down time of oven, put a tray filled with ice in oven cavity after shutting the oven down.</i> Once cooled, remove cook plate and other accessories from the cavity. 	
2. CLEAN OVEN INTERIOR	FOR OVENS WITH NON-STICK LINERS	FOR OVENS WITHOUT NON-STICK LINERS
2. CLEAN OVEN INTERIOR	<ol style="list-style-type: none"> Using a warm, damp, clean towel, wipe the oven interior. Rinse the towel and wring dry. Repeat 2-3 times to remove remaining particles from the oven. FOR STUBBORN DEBRIS, use OSOCL oven cleaner: <ol style="list-style-type: none"> Wear rubber gloves and safety glasses. Spray oven door and cavity with OSOCL oven cleaner. Avoid spraying into perforations. Allow cleaner to soak for 2 minutes. ⚠ DO NOT spray cleaning solution into perforations. WIPE OVEN INTERIOR. Using a damp clean towel, wipe the oven interior, then rinse the towel and wring dry. Repeat 2-3 times to remove remaining oven cleaner and particles from the oven. 	2. CLEAN OVEN INTERIOR
3. CLEANING ACCESSORIES	<ol style="list-style-type: none"> CLEANING THE OVEN TRAY: Allow the oven tray to cool before cleaning. <ol style="list-style-type: none"> Clean the oven tray with washing up liquid and a non-abrasive sponge or soft bristle brush. FOR STUBBORN DEBRIS, leave the oven tray to soak in hot, soapy water for 10 minutes. Burnt-on foods should lift off after soaking. Then, proceed with the detergent and plastic scouring pad, being sure to rinse thoroughly. ⚠ Do NOT use caustic cleaners (e.g. sodium hydroxide) as they react with aluminium and will degrade the surface. For other accessories, please refer to instruction sheet included in original packaging. 	
4. CLEAN OVEN EXTERIOR	<ol style="list-style-type: none"> CLEAN EXTERIOR DOOR and other surfaces with a clean cloth, sponge or nylon pad; using a mild detergent and warm water solution. CLEAN THE TOUCHSCREEN with a dry or damp microfibre cloth. ⚠ Do NOT use harsh chemicals. Do NOT spray liquid on the screen. 	
WEEKLY CLEANING		
1. CLEAN AIR FILTERS	<ol style="list-style-type: none"> Remove all 3 of the magnetic air filters located along the front base and sides of the oven. ⚠ WARNING: Do NOT operate oven without air filters in place. Wash filters in a mild detergent solution made with warm water. Rinse and dry thoroughly. Place the clean filters on oven front base and sides. 	

BEFORE CALLING SUPPORT

WARNING

To avoid electrical shock which can cause severe personal injury or death, do not remove outer case at any time. Only an authorized service technician should remove outer case.

This is a class A product. This could cause radio interference in a household environment. In this case, it may be necessary to take suitable measures.

WASTE MANAGEMENT AND ENVIRONMENTAL RESPECT



- This appliance is marked in accordance with the European Directive 2012/19/EU on electrical and electronic appliances (WEEE). WEEE contain both pollutants (which can cause negative consequences on the environment) and basic components (which can be reused).
- It is important that WEEE are subjected to specific treatments to remove and properly dispose of all pollutants and to recover all materials. Individuals can play an important role in ensuring that WEEE do not become an environmental problem; it is essential to follow a number of basic rules:
- WEEE must not be treated as household waste;
- WEEE must be taken to the appropriate collection points managed by the municipality or by registered companies.
- In many countries, for large WEEE, home collection may be present. When purchasing a new appliance, the old one may be returned to the dealer who must accept it free of charge on a one-for-one basis, provided that the appliance is of the equivalent type and has the same functions as the one purchased.

SETTINGS



Press the icon to access the Oracle settings.

- In this menu, you can modify the settings for:



Block settings



Software Update



User preferences
Brightness and Energy Savings,
Sounds, Language



Home icon size
settings



Wi-Fi settings



Energy Monitor



Cloud settings



Customer service



Date and time settings



SERVICE menu



USB settings
HACCP, INFO, Backup

SETTINGS

BLOCK SETTINGS

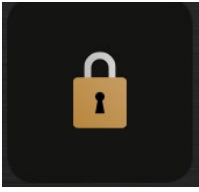

Press the icon to access the block settings

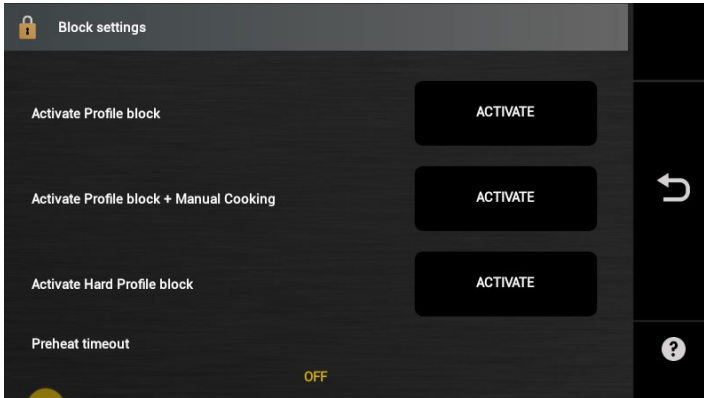

It is possible to activate the following blocks:

- **Activate profile block**

1st level (recipes are not deleted/stored)

- **Activate profile block + Manual cooking**

2nd level (only recipes and manual mode)

- **Activate hard profile block**

3rd level (recipes only)

- **Preheat timeout**

The aim is to reduce the power consumption and wear of the parts.

It is possible to set a timeout period from 1 to 10 minutes.

Once the preheat temperature is reached, if the door is not opened to insert the dish within the set time, the recipe is cancelled and the display returns to the initial page. A message informs the user that the time limit has been reached and that the recipe needs to be restarted.

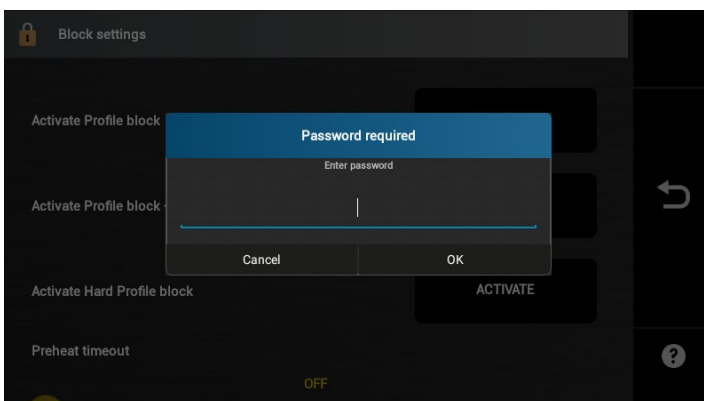

To activate the chosen block, press “**ACTIVATE**”, then enter the password and repeat it to confirm.

To unblock, press “**REMOVE**”, and enter the password.

SETTINGS

USER PREFERENCES

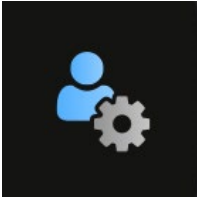

Press the icon to access the user preferences

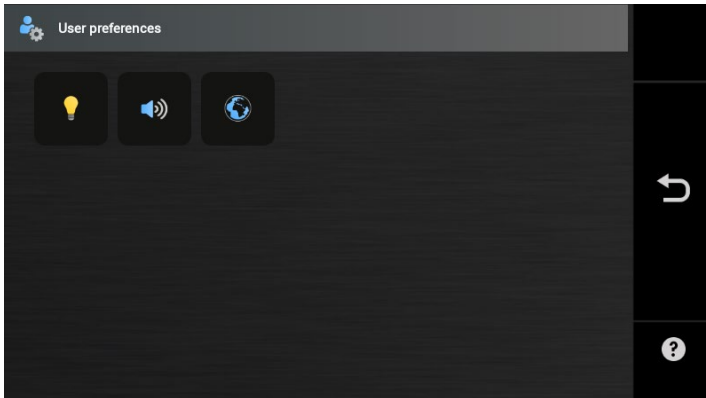

Brightness and Energy Saving:

Brightness settings, flashing light at end-of-cooking and Energy saving

Sounds:

Volume settings and sound configuration

Language:

Language setting, unit of measurement and keyboard choice/configuration

SETTINGS

USER PREFERENCES

BRIGHTNESS AND ENERGY SAVINGS



Press the icon to access the Brightness and Energy Savings settings

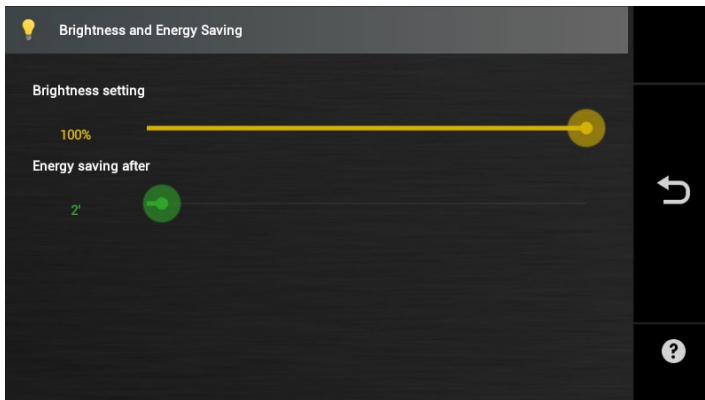

Brightness setting:

Drag the cursor to increase or decrease the brightness of the display

Energy savings after:

Drag the cursor to set the period of time after which Energy savings mode will start.

Drag the cursor to the left to disable the function.

SETTINGS

USER PREFERENCES

SOUNDS



Press the icon to access the Sound settings

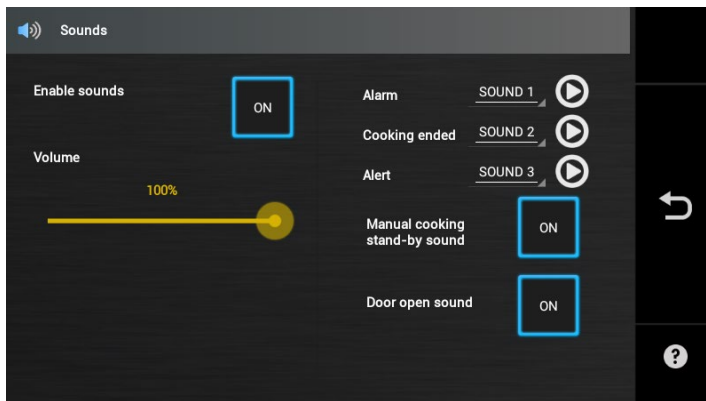

Enable sounds:

Set to ON to enable sounds

Volume setting:

Drag the cursor to increase or decrease the volume

Alarm: Select the sound for alarms

Cooking ended: Select the sound for end-of-cooking

Alert: Select the sound for messages/alerts

Manual cooking stand-by sound:

Set to ON to enable the sound for manual cooking stand-by

Door open sound:

Set to ON to enable the sound at the opening of the door

SETTINGS

USER PREFERENCES

LANGUAGE



Press the icon to access Languages and Unit of measurement

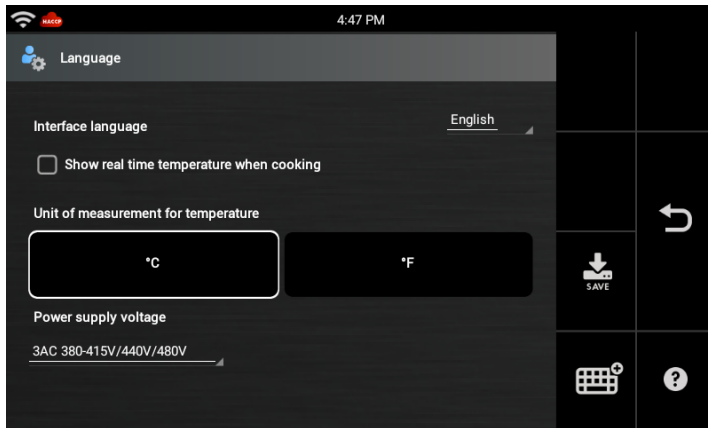

Set Interface language:

Select the language from the drop-down menu

Show real time temperature when cooking:

Click on the box to enable the function

Unit of measurement for temperature:

Click on the unit of measurement required (°Centigrade or °Fahrenheit)

Press the **SAVE** button to save the settings that have been entered

You can also load plugins for special keyboards, such as Korean, Chinese, etc. by selecting the keyboard icons.

SETTINGS

WIFI CONFIGURATION



Press the icon to access WIFI configuration

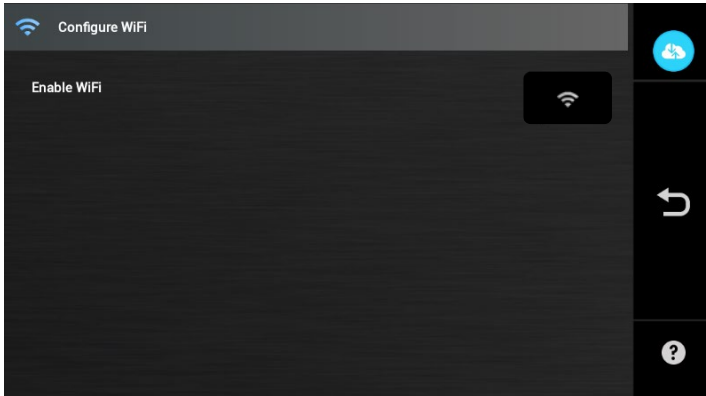

Press the icon “**Enable WIFI**” to access the WIFI networks available.

See page 29.

SETTINGS

CLOUD SETTINGS



Press the icon to access the Cloud

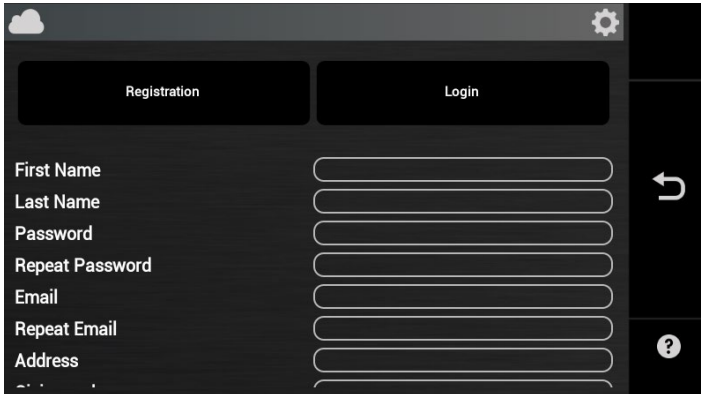

The screenshot shows a dark-themed user interface for registration. At the top left is a cloud icon, and at the top right is a gear icon. Below these are two buttons: "Registration" and "Login". The main area contains a list of input fields: "First Name", "Last Name", "Password", "Repeat Password", "Email", "Repeat Email", and "Address". Each field has a corresponding text input box. On the right side of the form, there is a vertical bar containing a back arrow icon and a question mark icon.

See page 30.

SETTINGS

DATE AND TIME

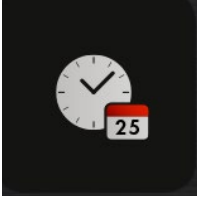

Press the icon to access the Date and Time settings

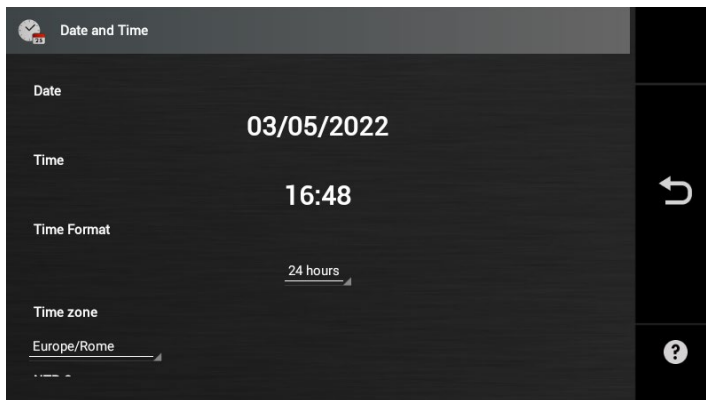

Date setting:

Click on date and select the date from the calendar

Time setting:

Click on time and set it by dragging the clock hands.

Time zone:

Select your time zone from the drop-down menu.

Time format:

Select the required time format from the drop-down menu.

Press the SAVE button to save the settings that have been entered

SETTINGS

USB



Press the icon to access the USB menu

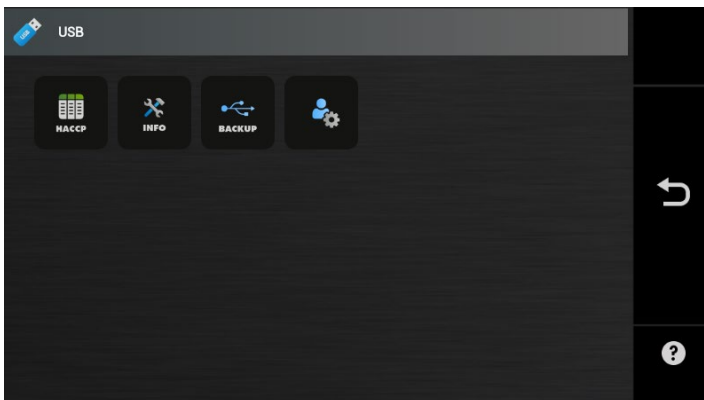

HACCP:

Allows you to download the HACCP log for a specific period of time.

INFO:

Create a backup of the technical data.

Backup:

Allows you to create and import a backup of recipes and/or settings.

User preferences backup:

Allows the creation or import of the user preferences backup.

SETTINGS

USB

HACCP



Press the icon to download the HACCP log

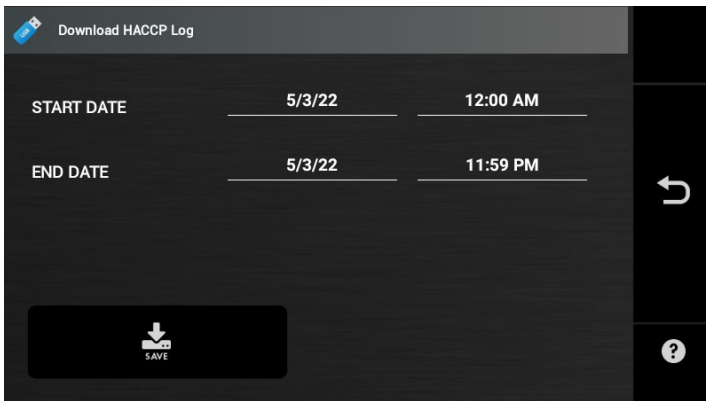

Select the required period for which to download the HACCP log:

Set the start date and time.

Set the end data and time.

Insert a USB key and press the SAVE button.

A pop-up window will show you that the operation has been successfully completed.

SETTINGS

USB

INFO



Press the icon to download the technical service information for the oven

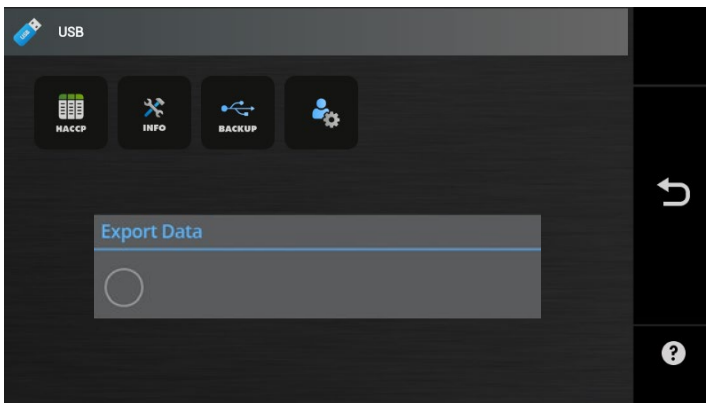

Allows you to download the technical service information log for the oven

Insert a USB key and press the INFO button

A pop-up window will indicate that the data is being exported to the USB key.

SETTINGS

USB

BACKUP



Press the icon to create or import a backup file of recipes and/or settings.

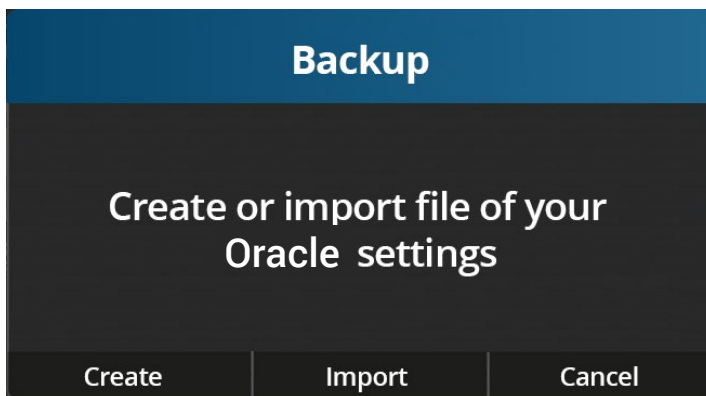

Insert USB key.

Select “**Create**” to create a backup.

Select the type of backup you want to create:

Recipes: Save the recipes only on the USB key

Settings: Save the settings only on the USB key

Complete: Save the recipes and settings on the USB key

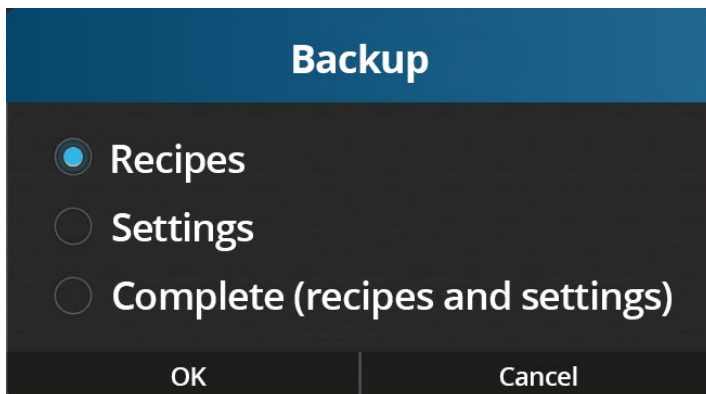

Or select “**Import**” to import the backup from the USB key.

Select the backup to import it.

SETTINGS

USB

USER PREFERENCES BACKUP



Press the icon to create or import the user preferences backup.

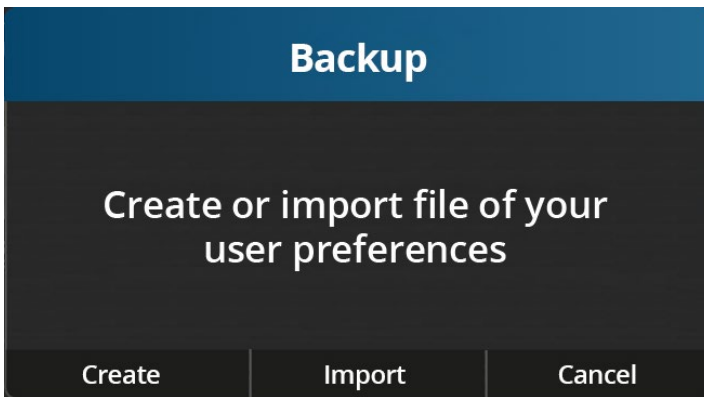

Insert USB key.

Select “**Create**” to run a user preferences backup.

Or select “**Import**” to import the backup from a USB.

Select the backup to import it.

SETTINGS

SOFTWARE UPDATE



Press the icon to access Software update.

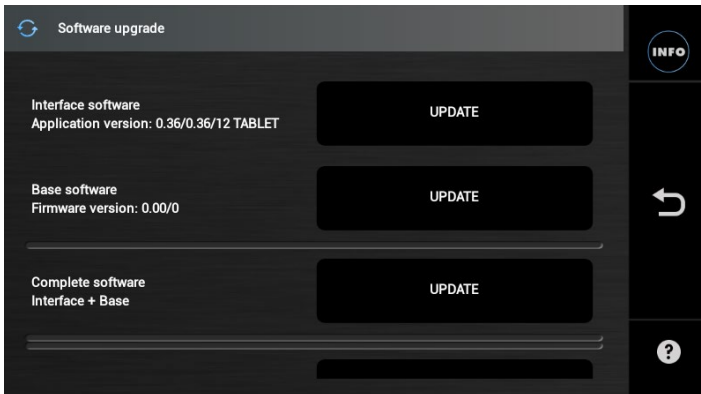

Select the type of software update you want to perform:

From USB key:

- Interface software)
- Base software)
- Complete software (Interface + Base)

From the Cloud:

- Complete software (Interface + Base)

See instructions on page 47

We recommend always running a Complete update

SETTINGS

HOME PAGE AND MESSAGES



Press the icon to access the home page settings and messages.

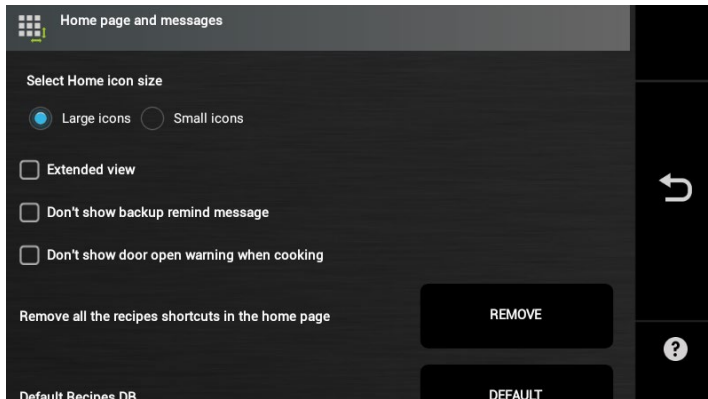

Select Home icon size:

Allows you to select the size of the icons on the home page.

Small icons: to view 20 icons on the home page

Large icons: to view 12 icons on the home page

Extended view:

If selected the extended home screen is displayed, without the menu buttons. Press the red arrow to make the menu buttons appear.

Don't show backup remind message:

If selected, the message reminding you to do a backup does not appear.

Don't show door open warning when cooking:

If selected, the warning message if the door is opened during cooking does not appear.

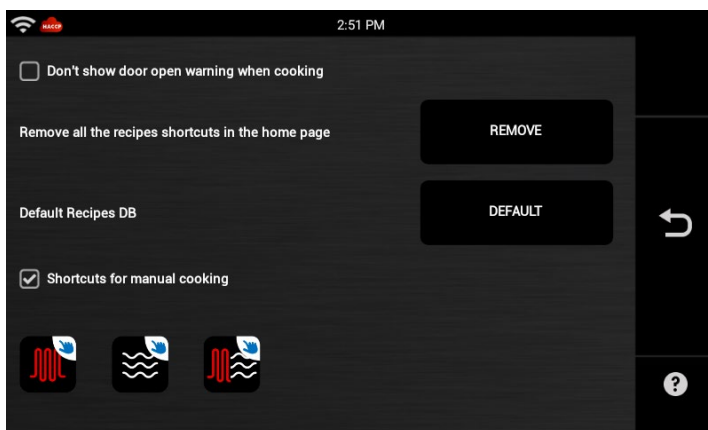

SETTINGS

HOME PAGE AND MESSAGES

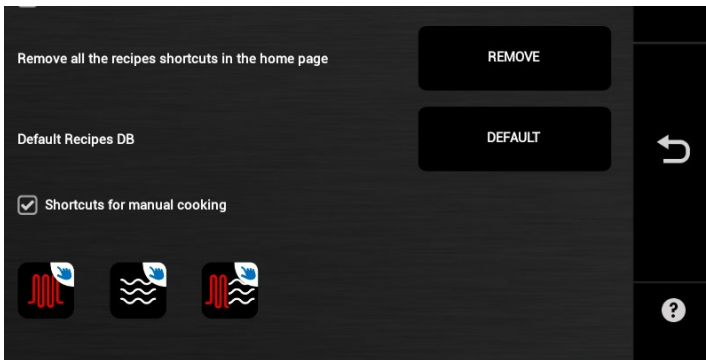

Remove all the recipe shortcuts in the home page:

Press the “REMOVE” key to eliminate all the recipe shortcuts from the home page.

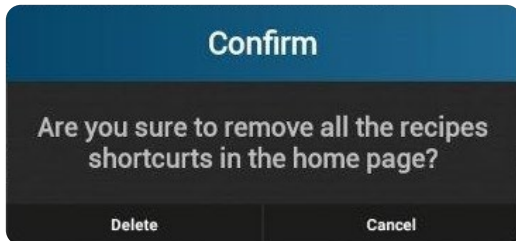

A pop-up window will appear asking for confirmation to remove all the recipe shortcuts from the home page. Confirm by pressing “Delete” or “Cancel” to eliminate the pop-up window.

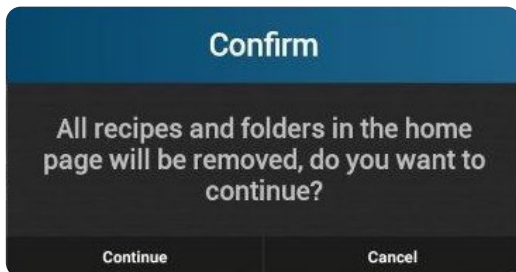

If you select “Delete”, another pop-up window will appear asking for confirmation to remove all the recipe shortcuts from the home page. Confirm by pressing “Continue” or “Cancel” to eliminate the pop-up window.

SETTINGS

HOME PAGE AND MESSAGES

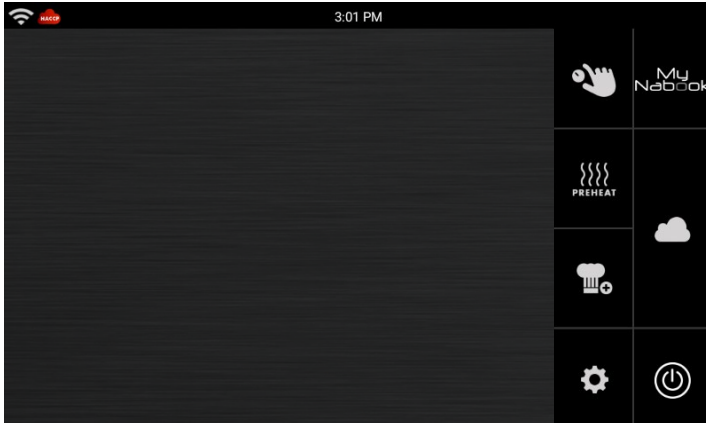

If you press “Continue”, the home page will be blank.

To add recipes to the home page, you can:

- Create new recipes
- Import recipes from My Nabook
- Import Recipes from the Cloud



Shortcuts for manual cooking:

If selected, the shortcuts for manual cooking and regeneration are shown on the home page.

SETTINGS

CONSUMPTION MONITOR



Press the icon to access the consumption monitor for the oven.

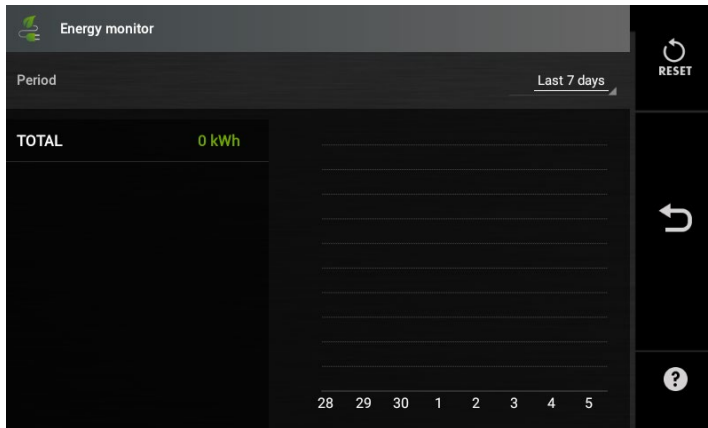

The Energy Monitor allows you to view the information about oven consumption in a specific period.

Period:

Select the period for which you wish to analyse the consumption data:

- Last operation
- Last 24 hours
- Last 7 days
- Last 30 days
- Last 12 months
- Search by date (to analyse a specific period of time)

A graph and a table of consumptions will be displayed for the selected period.

By selecting a value in the table, you switch to a detailed view

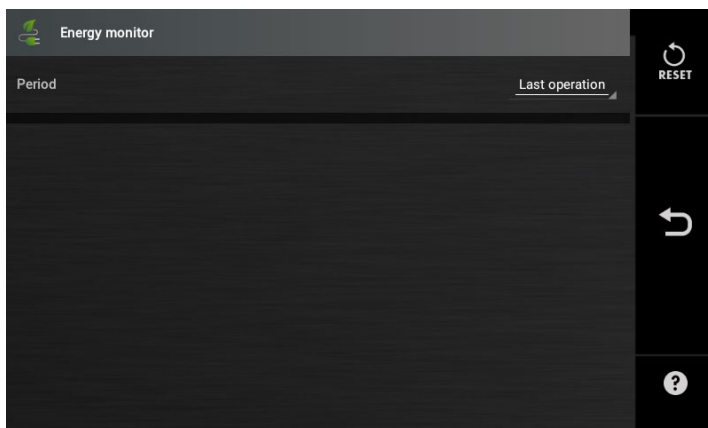

SETTINGS

CUSTOMER SERVICE



Press the icon to access the Customer service menu

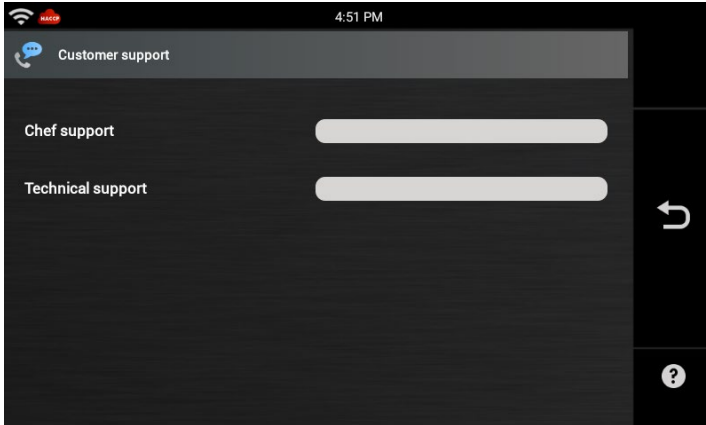

**Allows you to enter and view the customer service numbers:
Chef Support and Technical support.**

SETTINGS

SERVICE SETTINGS



Press the icon to access the Service settings.

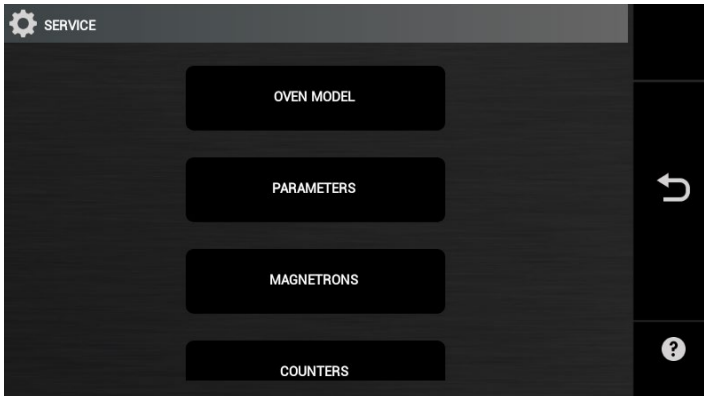

RESERVED FOR AUTHORISED TECHNICAL PERSONNEL

Press the “**SERVICE settings**” icon to access the Oven settings.

Enter the service password to access the functions.



* L A 9 0 0 3 8 9 0 0 *

LA90038900 MANUALE USO E MANUTENZIONE ORACLE - EN